

SAMSUNG

User Manual

SH37F

The color and the appearance may differ depending on the product, and the specifications are subject to change without prior notice to improve the performance.

Table of contents

Before Using the Product

Copyright	6
Safety Precautions	7
Symbols	7
Cleaning	7
Storage	8
Electricity and Safety	8
Installation	9
Operation	11

Preparations

Checking the Components	14
Components	14
Parts	15
Control Panel	15
Reverse Side	16
Anti-theft Lock	17
Remote Control	18
Connection Using an IR Stereo Cable (sold separately)	20
Before Installing the Product (Installation Guide)	21
Tilting Angle and Rotation	21
Ventilation	21
Using the COVER-JACK	23
Installing the Wall Mount	24
Installing the Wall Mount	24

Wall Mount Kit Specifications (VESA)	24
Remote Control (RS232C)	25
Cable Connection	25
Connection	28
Control Codes	29

Connecting and Using a Source Device

Before Connecting	38
Pre-connection Checkpoints	38
Connecting to a PC	38
Connection using the DVI-RGB cable	38
Connection using a DVI cable (Digital type)	39
Connection Using an HDMI-DVI Cable	39
Connection Using an HDMI Cable	40
Connection Using an DP Cable	40
Connecting an External Monitor	41
Connecting to a Video Device	42
Connection Using an HDMI-DVI Cable	42
Connection Using an HDMI Cable	43
Connecting to an Audio System	43
Connecting the LAN Cable	44
Changing the Input source	45
Source	45

Using MDC

MDC Program Installation/Uninstallation	46
Installation	46
Uninstallation	46
Connecting to MDC	47
Using MDC via RS-232C (serial data communications standards)	47
Using MDC via Ethernet	48

Home feature

Player	50
Approving a connected device from the server	51
Network Channel	55
Local Channel	55
Published Content	55
Network File	55
My Templates	55
Available features in the Player page	56
Player page Settings menu	57
When Content is Running	59
File Formats Compatible with Player	61
File Formats Compatible with Videowall	66
Schedule	68
Available features in the Schedule page	68
Clone Product	70
ID Settings	71

Table of contents

Device ID	71
PC Connection Cable	71
Device ID Auto Set	71
<hr/>	
Video Wall	72
Apply to	72
Video Wall	73
<hr/>	
Network Status	74
<hr/>	
Picture Mode	75
<hr/>	
On/Off Timer	76
On Timer	76
Off Timer	77
Holiday Management	77
<hr/>	
Ticker	78
<hr/>	
More settings	78
<hr/>	
URL Launcher	79

Screen Adjustment

Picture Mode	80
<hr/>	
Backlight / Contrast / Brightness / Sharpness / Color / Tint (G/R)	81
<hr/>	
Color Temperature	82
<hr/>	
White Balance	83
2 Point	83
10 Point	83

Gamma	84
<hr/>	
Calibrated Value	84
<hr/>	
Advanced Settings	85
Dynamic Contrast	86
Black Tone	86
Flesh Tone	86
RGB Only Mode	86
Color Space	86
Motion Lighting	86
<hr/>	
Picture Options	87
Color Tone	88
Digital Clean View	88
MPEG Noise Filter	88
HDMI Black Level	89
Film Mode	89
Dynamic Backlight	89
<hr/>	
Picture Size	90
Picture Size	90
Position	91
Zoom/Position	91
Resolution	92
<hr/>	
Auto Adjustment	93
<hr/>	
PC Screen Adjustment	93
<hr/>	
Picture Off	94
<hr/>	
Reset Picture	94

OnScreen Display

Display Orientation	95
Source Content Orientation	95
Aspect Ratio	95
<hr/>	
Screen Protection	96
Auto Protection Time	96
Screen Burn Protection	96
<hr/>	
Message Display	99
Schedule Channel Info	99
Source Info	99
No Signal Message	99
MDC Message	99
Download Status Message	99
<hr/>	
Menu Language	100
<hr/>	
Reset OnScreen Display	100

Sound Adjustment

HDMI Sound	101
<hr/>	
Speaker Settings	102
Sound Output	102

Table of contents

Network

Network Status	103
Network Settings	103
Network type	103
Network Settings (Wired)	104
Multimedia Device Settings	106
Server Network Settings	106
Connect to Server	106
MagicInfo Mode	106
Server Access	106
FTP Mode	106
Device Name	106

System

Accessibility	107
Voice Guide	107
Menu Transparency	108
High Contrast	108
Enlarge	108
Setup	109
Initial settings (System)	109
Time	110
Clock Set	110
DST	110
Sleep Timer	110
Power On Delay	110

Auto Source Switching	111
Auto Source Switching	111
Primary Source Recovery	111
Primary Source	111
Secondary Source	111
Power Control	112
Auto Power On	112
PC Module Power	112
Max. Power Saving	112
Standby Control	113
Power Button	113
Network Standby	113
Eco Solution	114
Energy Saving	114
Eco Sensor	114
Screen Lamp Schedule	115
No Signal Power Off	115
Auto Power Off	115
Temperature Control	116
Device Manager	117
Keyboard Settings	117
Mouse Settings	118
Pointer Settings	119
Play via	120
Change PIN	120
Security	121
Safety Lock	121
USB Auto Play Lock	121
Mobile Connection Lock	121

General	122
Smart Security	122
BD Wise	123
Anynet+ (HDMI-CEC)	124
Troubleshooting for Anynet+	126
HDMI Hot Plug	128
DivX® Video On Demand	128
Game Mode	128
Reset System	129

Support

Software Update	130
Update now	130
Auto Update	130
Contact Samsung	130
Go to Home	130
Reset All	130

Playing photos, videos and music (Media Play)

Read the following before using media play with a USB device	131
Using a USB device	133
Playing media content from a PC/mobile device	134

Table of contents

Features provided in the media content list page	135
Menu items in the media content list page	136
<hr/>	
Available buttons and features during photo playback	137
<hr/>	
Available buttons and features during video playback	138
<hr/>	
Available buttons and features during music playback	139
<hr/>	
Supported Subtitle and Media play file formats	140
Subtitle	140
Supported image resolutions	140
Supported music file formats	141
Supported Video Formats	141

Troubleshooting Guide

Requirements Before Contacting Samsung Customer Service Center	143
Testing the Product	143
Checking the Resolution and Frequency	143
Check the followings.	144
<hr/>	
Q & A	151

Specifications

General	152
<hr/>	
Preset Timing Modes	154

Appendix

Responsibility for the Pay Service (Cost to Customers)	156
Not a product defect	156
A Product damage caused by customer's fault	156
Others	156
<hr/>	
Optimum Picture Quality and Afterimage Burn-in Prevention	157
Optimum Picture Quality	157
Prevention of Afterimage Burn-in	157
<hr/>	
License	159
<hr/>	
Terminology	160

Chapter 01

Before Using the Product

Copyright

The contents of this manual are subject to change without notice to improve quality.

© 2016 Samsung Electronics

Samsung Electronics owns the copyright for this manual.

Use or reproduction of this manual in parts or entirety without the authorization of Samsung Electronics is prohibited.

Microsoft, Windows are registered trademarks of Microsoft Corporation.

VESA, DPM and DDC are registered trademarks of the Video Electronics Standards Association.

Ownership of all other trademarks is attributed to their due owner.

Safety Precautions

Caution

RISK OF ELECTRIC SHOCK DO NOT OPEN

Caution : TO REDUCE THE RISK OF ELECTRIC SHOCK, DO NOT REMOVE COVER. (OR BACK)
THERE ARE NO USER SERVICEABLE PARTS INSIDE.
REFER ALL SERVICING TO QUALIFIED PERSONNEL.



This symbol indicates that high voltage is present inside.

It is dangerous to make any kind of contact with any internal part of this product.



This symbol alerts you that important literature concerning operation and maintenance has been included with this product.

Symbols

Warning

A serious or fatal injury may result if instructions are not followed.

Caution

Personal injury or damage to properties may result if instructions are not followed.



Activities marked by this symbol are prohibited.



Instructions marked by this symbol must be followed.

Cleaning

- Exercise care when cleaning as the panel and exterior of advanced LCDs are easily scratched.
- Take the following steps when cleaning.
- The following images are for reference only. Real-life situations may differ from what is shown in the images.

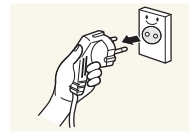

- 1 Power off the product and computer.
- 2 Disconnect the power cord from the product.

- Hold the power cable by the plug and do not touch the cable with wet hands. Otherwise, an electric shock may result.

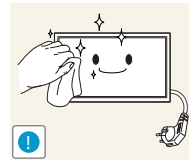

- 3 Wipe the product with a clean, soft and dry cloth.



- Do not use detergents that contain alcohol, solvent or surface-active agents.



- Do not spray water or detergent directly on the product.

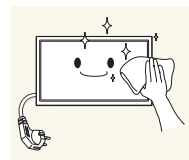

- 4 Wet a soft and dry cloth in water and wring thoroughly to clean the exterior of the product.

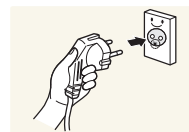

- 5 Connect the power cord to the product when cleaning is finished.
- 6 Power on the product and computer.

Storage

Due to the characteristics of high-glossy products, using a UV humidifier nearby may create white-colored stains on the product.

- Contact Customer Service Center if the inside of the product needs cleaning (service fee will be charged).

Electricity and Safety

- The following images are for reference only. Real-life situations may differ from what is shown in the images.

Warning

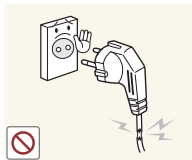

Do not use a damaged power cord or plug, or a loose power socket.

- An electric shock or fire may result.

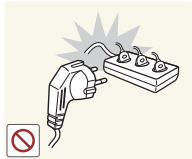

Do not use multiple products with a single power socket.

- Overheated power sockets may cause a fire.



Do not touch the power plug with wet hands. Otherwise, an electric shock may result.

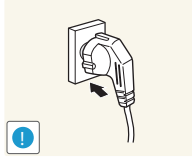

Insert the power plug all the way in so it is not loose.

- An unsecure connection may cause a fire.

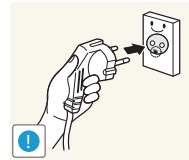

Connect the power plug to a grounded power socket (type 1 insulated devices only).

- An electric shock or injury may result.

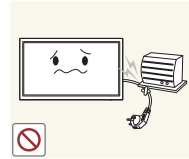

Do not bend or pull the power cord with force. Be careful not to leave the power cord under a heavy object.

- Damage to the cord may result in a fire or electric shock.



Do not place the power cord or product near heat sources.

- A fire or electric shock may result.

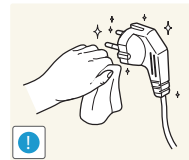

Clean any dust around the pins of the power plug or the power socket with a dry cloth.

- A fire may result.

Caution

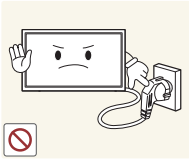

Do not disconnect the power cord while the product is being used.

- The product may become damaged by an electric shock.

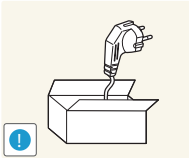

Only use the power cord provided with your product by Samsung. Do not use the power cord with other products.

- A fire or electric shock may result.

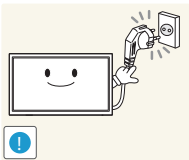

Keep the power socket where the power cord is connected unobstructed.

- The power cord must be disconnected to cut off power to the product when an issue occurs.
- Note that the product is not completely powered down by using only the power button on the remote.

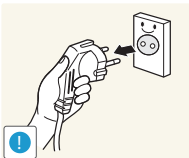

Hold the plug when disconnecting the power cord from the power socket.

- An electric shock or fire may result.

Installation

Warning



DO NOT PLACE CANDLES, INSECT REPELLANTS OR CIGARETTES ON TOP OF THE PRODUCT. DO NOT INSTALL THE PRODUCT NEAR HEAT SOURCES.

- A fire may result.

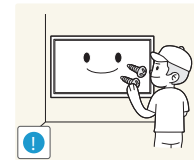

Have a technician install the wall-mount hanger.

- Installation by an unqualified person can result in an injury.
- Only use approved cabinets.



Do not install the product in poorly ventilated spaces such as a bookcase or closet.

- An increased internal temperature may cause a fire.

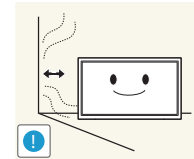

Install the product at least 10 cm away from the wall to allow ventilation.

- An increased internal temperature may cause a fire.

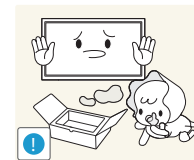

Keep the plastic packaging out of the reach of children.

- Children may suffocate.



Do not install the product on an unstable or vibrating surface (insecure shelf, sloped surface, etc.)

- The product may fall and become damaged and/or cause an injury.
- Using the product in an area with excess vibration may damage the product or cause a fire.

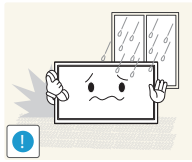

Do not install the product in a vehicle or a place exposed to dust, moisture (water drips, etc.), oil, or smoke.

- A fire or electric shock may result.

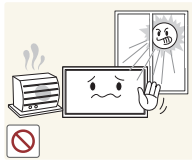

Do not expose the product to direct sunlight, heat, or a hot object such as a stove.

- The product lifespan may be reduced or a fire may result.

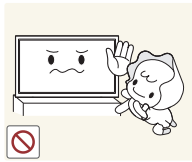

Do not install the product within the reach of young children.

- The product may fall and injure children.
- As the front is heavy, install the product on a flat and stable surface.



Edible oil, such as soybean oil, can damage or deform the product. Do not install the product in a kitchen or near a kitchen counter.

Caution

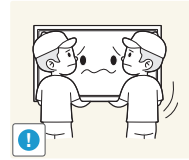

Do not drop the product while moving.

- Product failure or personal injury may result.

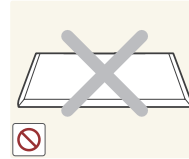

Do not set down the product on its front.

- The screen may become damaged.

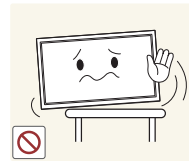

When installing the product on a cabinet or shelf, make sure that the bottom edge of the front of the product is not protruding.

- The product may fall and become damaged and/or cause an injury.
- Install the product only on cabinets or shelves of the right size.

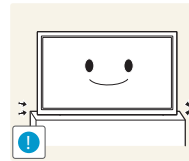

Set down the product gently.

- Product failure or personal injury may result.



Installing the product in an unusual place (a place exposed to a lot of fine dust, chemical substances, extreme temperatures or a significant presence of moisture, or a place where the product will operate continuously for an extended period of time) may seriously affect its performance.

- Be sure to consult Samsung Customer Service Center if you want to install the product at such a place.

Operation

Warning



There is a high voltage inside the product. Never disassemble, repair or modify the product yourself.

- A fire or electric shock may result.
- Contact Samsung Customer Service Center for repairs.

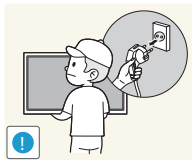

Before moving the product, turn off the power switch and disconnect the power cable and all other connected cables.

- Damage to the cord may result in a fire or electric shock.

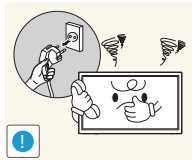

If the product generates abnormal sounds, a burning smell or smoke, disconnect the power cord immediately and contact Samsung Customer Service Center.

- An electric shock or fire may result.

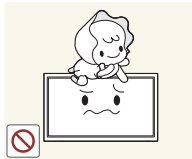

Do not let children hang from the product or climb on top of it.

- Children may become injured or seriously harmed.



If the product is dropped or the outer case is damaged, turn off the power switch and disconnect the power cord. Then contact Samsung Customer Service Center.

- Continued use can result in a fire or electric shock.

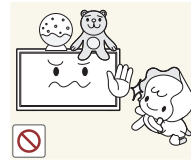

Do not leave heavy objects or items that children like (toys, sweets, etc.) on top of the product.

- The product or heavy objects may fall as children try to reach for the toys or sweets resulting in a serious injury.

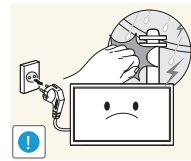

During a lightning or thunderstorm, power off the product and remove the power cable.

- A fire or electric shock may result.

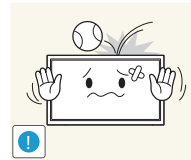

Do not drop objects on the product or apply impact.

- A fire or electric shock may result.

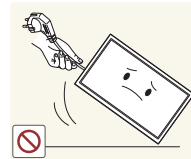

Do not move the product by pulling the power cord or any cable.

- Product failure, an electric shock or fire may result from a damaged cable.

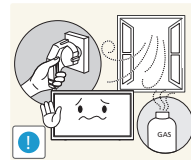

If a gas leakage is found, do not touch the product or power plug. Also, ventilate the area immediately.

- Sparks can cause an explosion or fire.

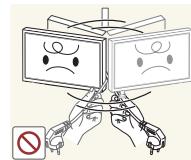

Do not lift or move the product by pulling the power cord or any cable.

- Product failure, an electric shock or fire may result from a damaged cable.

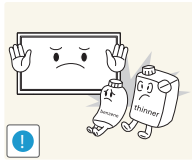

Do not use or keep combustible spray or an inflammable substance near the product.

- An explosion or fire may result.

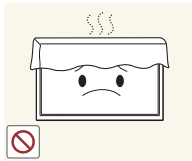

Ensure the vents are not blocked by tablecloths or curtains.

- An increased internal temperature may cause a fire.

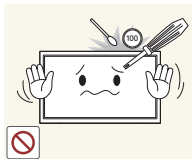

Do not insert metallic objects (chopsticks, coins, hairpins, etc) or objects that burn easily (paper, matches, etc) into the product (via the vent or input/output ports, etc).

- Be sure to power off the product and disconnect the power cord when water or other foreign substances have entered the product. Then contact Samsung Customer Service Center.
- Product failure, an electric shock or fire may result.

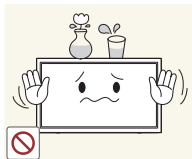

Do not place objects containing liquid (vases, pots, bottles, etc) or metallic objects on top of the product.

- Be sure to power off the product and disconnect the power cord when water or other foreign substances have entered the product. Then contact Samsung Customer Service Center.
- Product failure, an electric shock or fire may result.

Caution

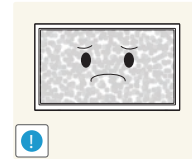

Leaving the screen fixed on a stationary image for an extended period of time may cause afterimage burn-in or defective pixels.

- Activate power-saving mode or a moving-picture screen saver if you will not be using the product for an extended period of time.

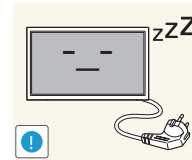

Disconnect the power cord from the power socket if you do not plan on using the product for an extended period of time (vacation, etc).

- Dust accumulation combined with heat can cause a fire, electric shock or electric leakage.

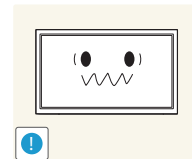

Use the product at the recommended resolution and frequency.

- Your eyesight may deteriorate.



Do not hold the product upside-down or move it by holding the stand.

- The product may fall and become damaged or cause an injury.

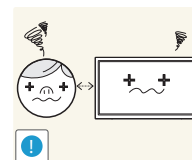

Looking at the screen too close for an extended period of time can deteriorate your eyesight.



Do not use humidifiers or stoves around the product.

- A fire or electric shock may result.

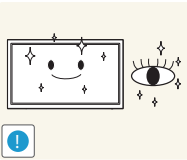

Rest your eyes for more than 5 minutes for every 1 hour of product use.

- Eye fatigue will be relieved.



Do not touch the screen when the product has been turned on for an extended period of time as it will become hot.

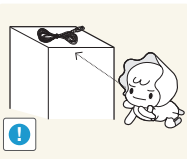

Store small accessories out of the reach of children.

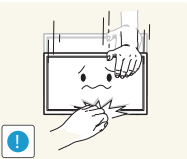

Exercise caution when adjusting the product angle or stand height.

- Your hand or finger may get stuck and injured.
- Tilting the product at an excessive angle may cause the product to fall and an injury may result.

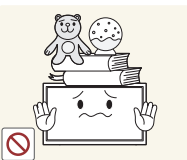

Do not place heavy objects on the product.

- Product failure or personal injury may result.



When using headphones or earphones, do not turn the volume too high.

- Having the sound too loud may damage your hearing.

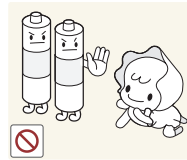

Be careful that children do not place the battery in their mouths when removed from the remote control. Place the battery in a location that children or infants cannot reach.

- If children have had the battery in their mouths, consult your doctor immediately.

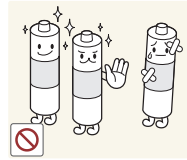

When replacing the battery, insert it with the right polarity (+, -).

- Otherwise, the battery may become damaged or it may cause fire, personal injury or damage due to leakage of the internal liquid.

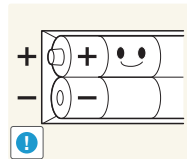

Use only the specified standardized batteries, and do not use a new battery and a used battery at the same time.

- Otherwise, the batteries may be damaged or cause fire, personal injury or damage due to a leakage of the internal liquid.

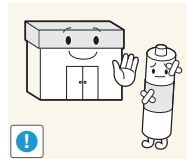

The batteries (and rechargeable batteries) are not ordinary refuse and must be returned for recycling purposes. The customer is responsible for returning the used or rechargeable batteries for recycling.

- The customer can return used or rechargeable batteries to a nearby public recycling center or to a store selling the same type of the battery or rechargeable battery.

Chapter 02

Preparations

Checking the Components

Components

- Contact the vendor where you purchased the product if any components are missing.
- The pictures may look different from the actual components.
- A stand is not provided with the product. To install a stand, you can purchase one separately.
- The RS232C adapter can be used to connect to another monitor using the D-SUB (9-pin) type RS232C cable.

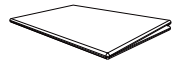

Quick Setup Guide



Warranty card
(Not available in some locations)



Regulatory guide



Power cord

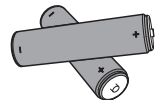

Batteries
(Not available in some locations)



Remote Control



RS232C(IN) adapter

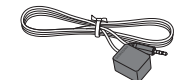

External remote control sensor

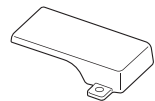

COVER-JACK



Screw (M3L8, 1EA)

Parts

Control Panel

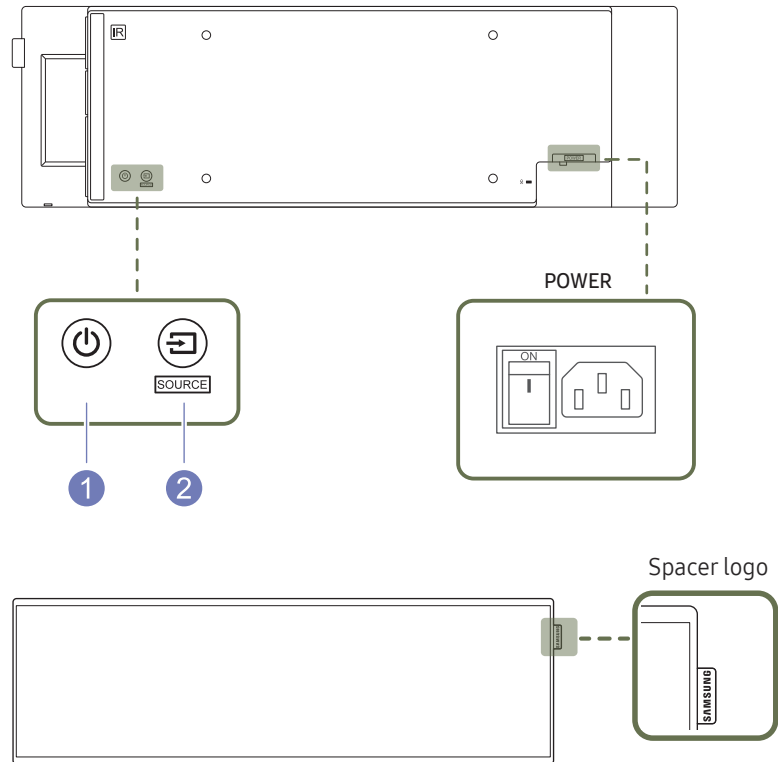

— The color and shape of parts may differ from what is shown. Specifications are subject to change without notice to improve quality.

Parts	Description
1 Power button	Use this button for turning the Display on and off.
2 SOURCE button	Select the connected input source.
Spacer logo	Do not pull on the spacer logo using force. The logo may tear or break off.

Reverse Side

— The color and shape of parts may differ from what is shown.
Specifications are subject to change without notice to improve quality.

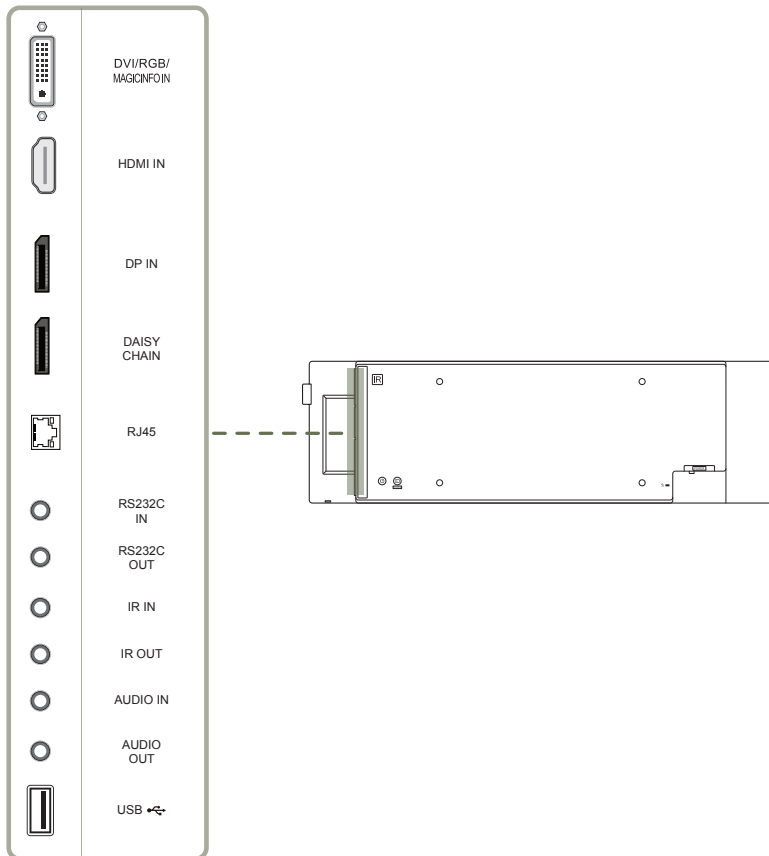

Port	Description
DVI/RGB/MAGICINFO IN	DVI: Connects to a source device using a DVI cable or HDMI-DVI cable. RGB: Connects a D-SUB cable (via a DVI-RGB adapter) or a DVI-RGB cable to a PC. MAGICINFO IN: Use the (dedicated) DP-DVI cable when connecting a network box (sold separately).
HDMI IN	Connects to a source device using an HDMI cable.
DP IN	Connects to a PC using a DP cable.
DAISY CHAIN	Connects to another product using a DP cable.
RJ45	Connects to MDC using a LAN cable.
RS232C IN	Connects to MDC using an RS232C adapter.
RS232C OUT	
IR IN	Supplies power to the external sensor board or receives the external remote control sensor signal.
IR OUT	Receives the remote control signal via the external sensor board and outputs the signal via LOOP OUT.
AUDIO IN	Receives sound from a PC via an audio cable.
AUDIO OUT	Connects to the audio of a source device.
USB	Connect to a USB memory device.

Anti-theft Lock

- An anti-theft lock allows you to use the product securely even in public places.
- The locking device shape and locking method depend on the manufacturer. Refer to the user guide provided with your anti-theft locking device for details.
- The following images are for reference only. Real-life situations may differ from what is shown in the images.

To lock an anti-theft locking device:

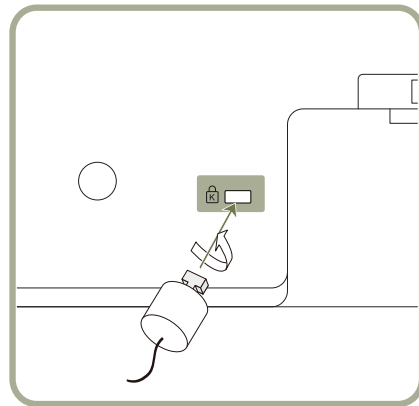

- 1 Fix the cable of your anti-theft locking device to a heavy object such as a desk.
- 2 Put one end of the cable through the loop on the other end.
- 3 Insert the locking device into the anti-theft lock slot at the back of the product.
- 4 Lock the locking device.
 - An anti-theft locking device can be purchased separately.
 - Refer to the user guide provided with your anti-theft locking device for details.
 - Anti-theft locking devices can be purchased at electronics retailers or online.

Remote Control

- Using other display devices in the same space as the remote control of this product can cause the other display devices to be inadvertently controlled.
- A button without a description in the image below is not supported on the product.

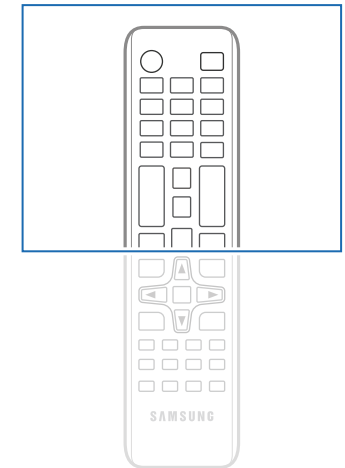
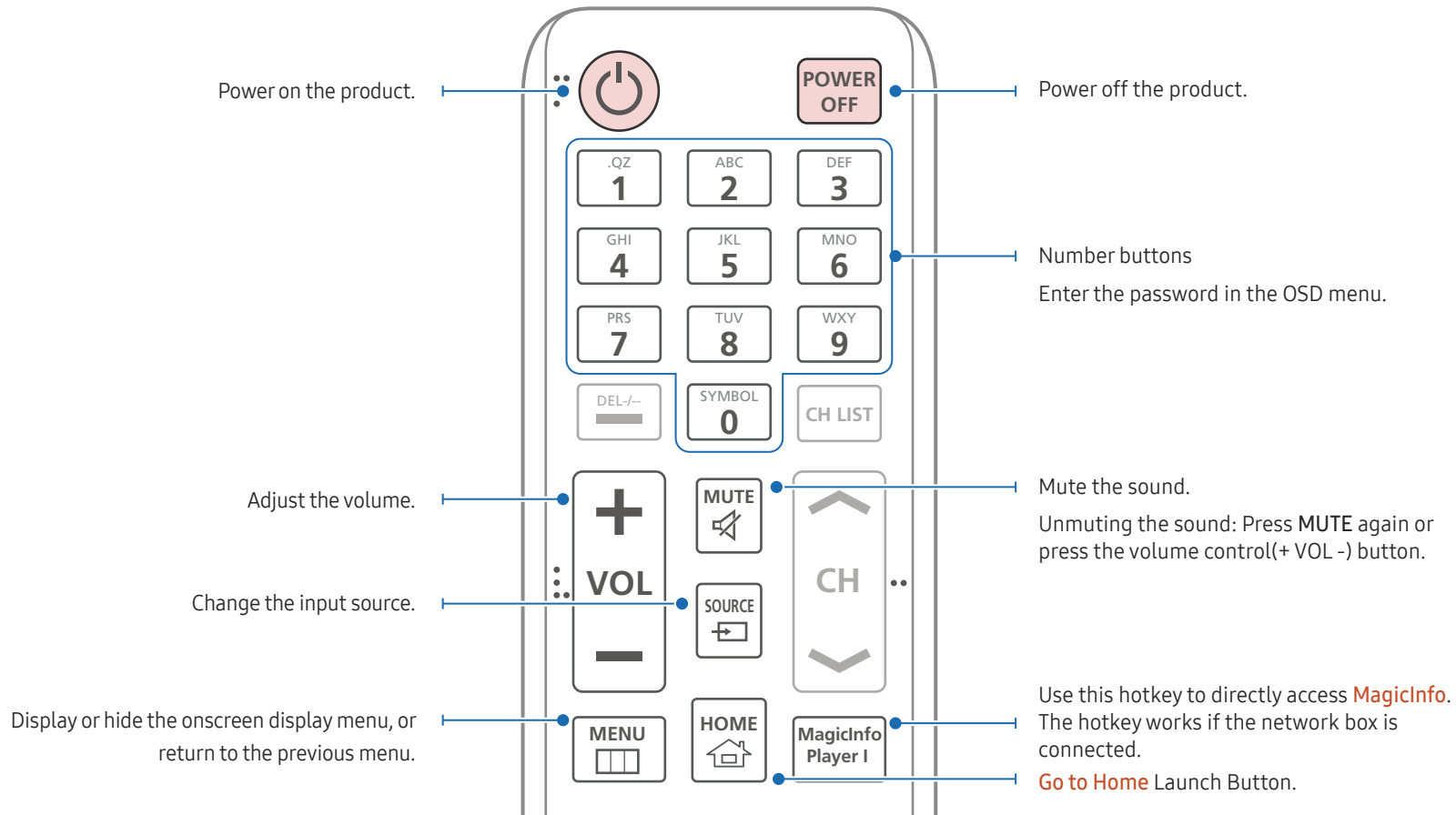

– Remote control button functions may differ for different products.

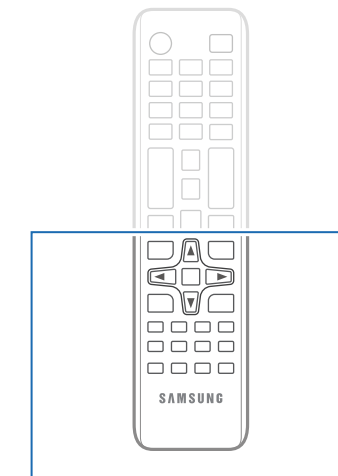
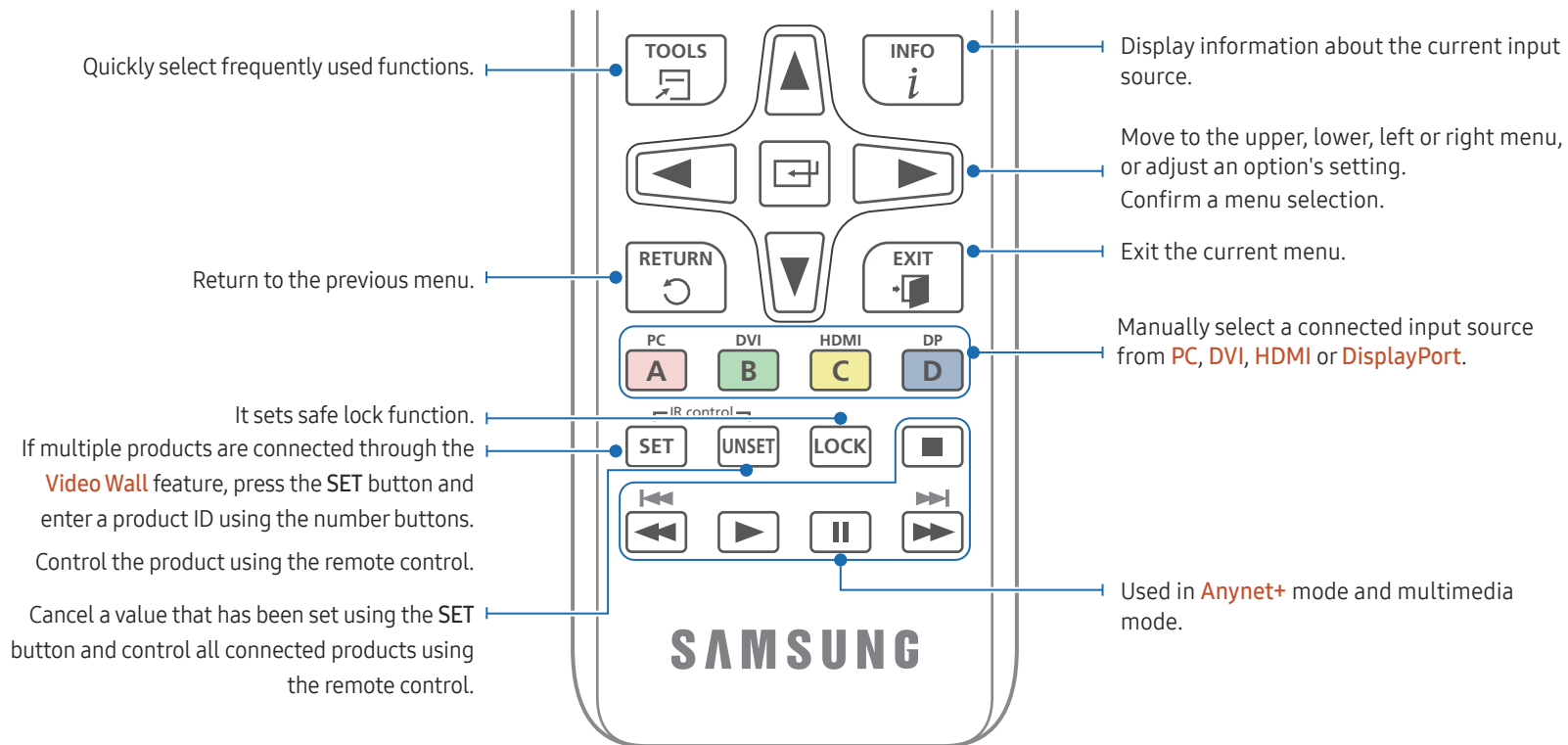

– Remote control button functions may differ for different products.

To place batteries in the remote control

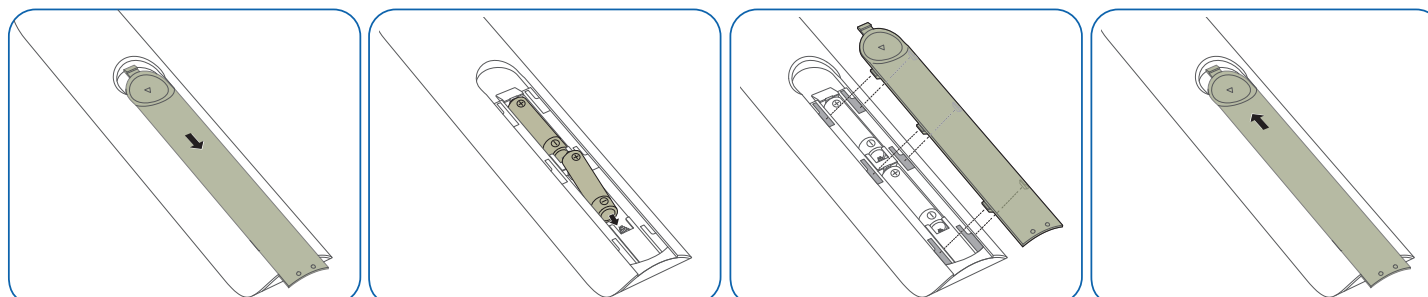

Connection Using an IR Stereo Cable (sold separately)

Make sure to connect the external remote control sensor while the product is powered off. Then, power on the product.

Controlling more than one display product using your remote control

- Connect the IR OUT port on the product to the IR IN port on the other display product using the dedicated stereo cable.
- A command sent from the remote control pointed at product ① will be received by both display products ① and ②.

— The appearance may differ depending on the product.

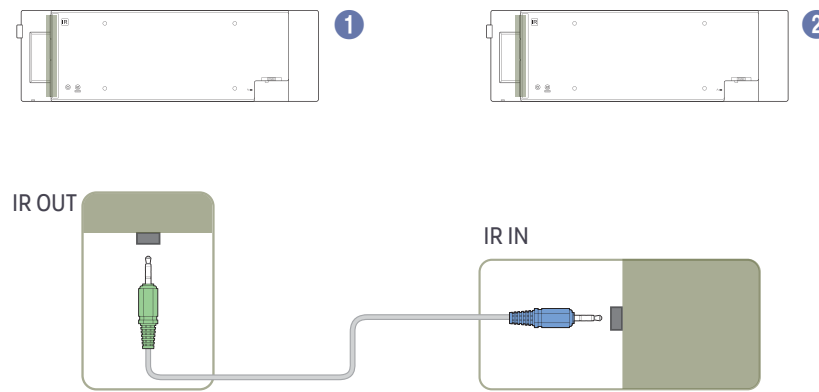

Controlling more than one display product using an external remote control sensor

- A command sent from the remote control pointed at product ① (to which the external remote control sensor is connected) will be received by both display products ① and ②.

— The appearance may differ depending on the product.

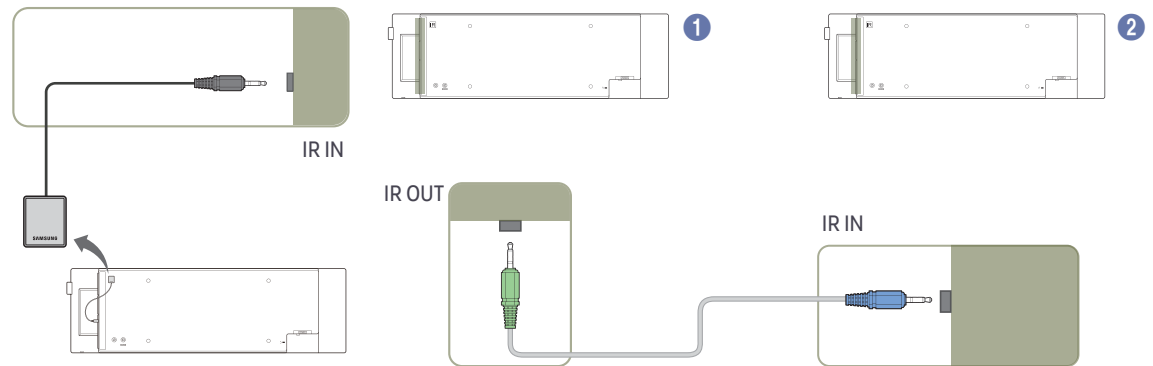

Before Installing the Product (Installation Guide)

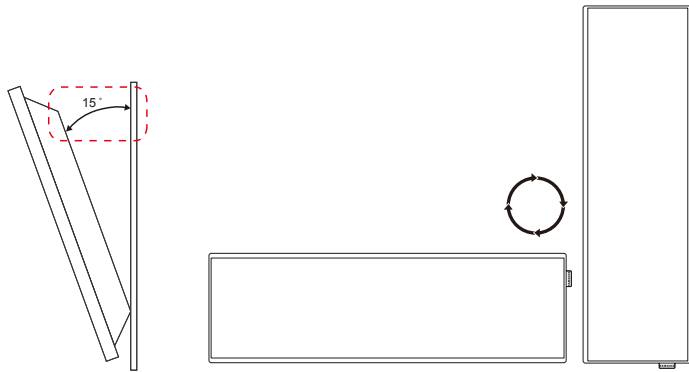

To prevent injury, this apparatus must be securely attached to the floor/wall in accordance with the installation instructions.

- Ensure that an authorized installation company installs the wall mount.
- Otherwise, it may fall and cause personal injury.
- Make sure to install the specified wall mount.

Tilting Angle and Rotation

— Contact Samsung Customer Service Center for further details.

- The product can be tilted at a maximum angle of 15° from a perpendicular wall surface.
- To use the product in portrait orientation, rotate the product clockwise until the spacer logo faces down.

Ventilation

Installation on a Perpendicular Wall

A Minimum 40 mm

B Ambient temperature: Under 35°C

- When installing the product on a perpendicular wall, allow at least 40 mm of space between the product and wall surface for ventilation and ensure that the ambient A temperature is kept below 35°C.

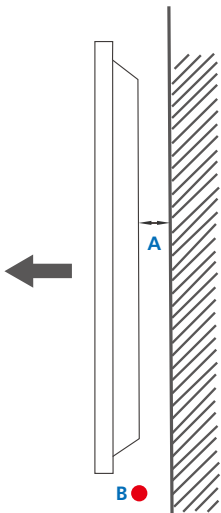

Figure 1.1 Side view

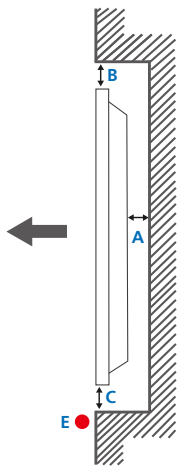
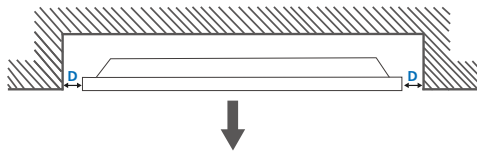

Figure 1.2 Side view

Figure 1.3 Side view



Installation on an Indented Wall

— Contact Samsung Customer Service Center for further details.

Plane view

A Minimum 40 mm

B Minimum 70 mm

C Minimum 50 mm

D Minimum 50 mm

E Ambient temperature: Under 35°C

— When installing the product on an indented wall, allow at least the space specified above between the product and wall for ventilation and ensure that the ambient temperature is kept below 35°C.

Using the COVER-JACK

To protect your USB device from theft, install the COVER-JACK that came with the product.

— The following images are for reference only. Real-life situations may differ from what is shown in the images.

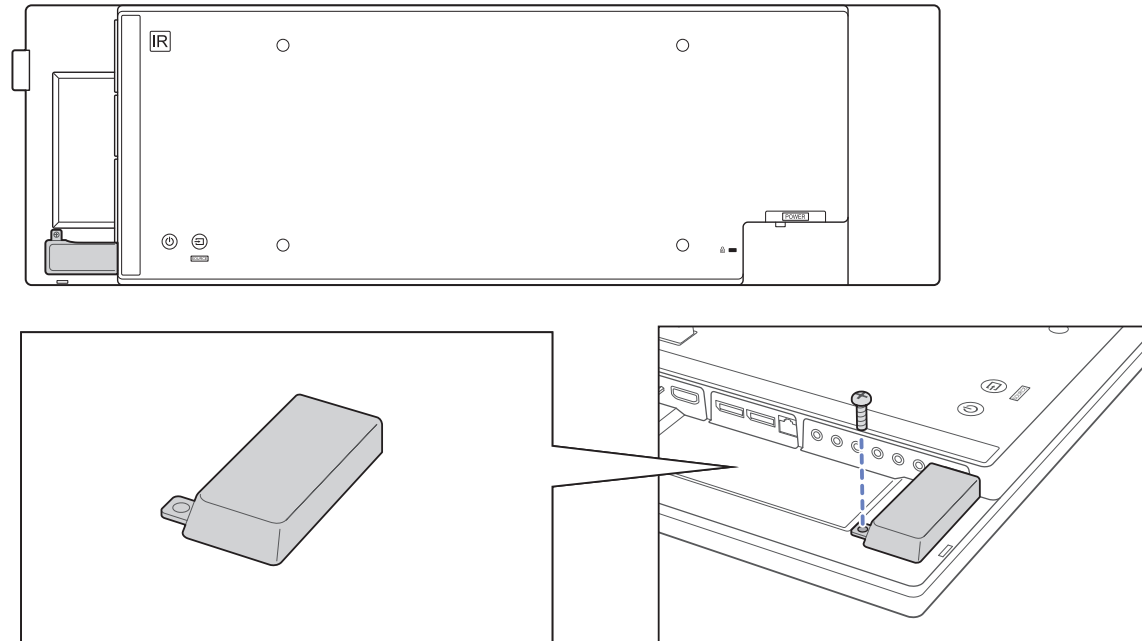

Installing the Wall Mount

Installing the Wall Mount

The wall mount kit (sold separately) allows you to mount the product on the wall.

For detailed information on installing the wall mount, see the instructions provided with the wall mount.

We recommend you contact a technician for assistance when installing the wall mount bracket.

Samsung Electronics is not responsible for any damage to the product or injury to yourself or others if you elect to install the wall mount on your own.

Wall Mount Kit Specifications (VESA)

— Install your wall mount on a solid wall perpendicular to the floor. Before attaching the wall mount to surfaces other than plaster board, please contact your nearest dealer for additional information.

If you install the product on a slanted wall, it may fall and result in severe personal injury.

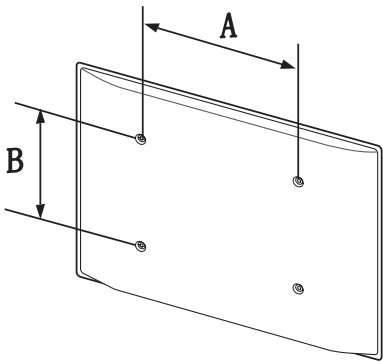

- Samsung wall mount kits contain a detailed installation manual and all parts necessary for assembly are provided.
- Do not use screws that are longer than the standard length or do not comply with the VESA standard screw specifications. Screws that are too long may cause damage to the inside of the product.
- For wall mounts that do not comply with the VESA standard screw specifications, the length of the screws may differ depending on the wall mount specifications.
- Do not fasten the screws too firmly. This may damage the product or cause the product to fall, leading to personal injury. Samsung is not liable for these kinds of accidents.
- Samsung is not liable for product damage or personal injury when a non-VESA or non-specified wall mount is used or the consumer fails to follow the product installation instructions.
- Do not mount the product at more than a 15 degree tilt.
- Always have two people mount the product on a wall.
- Standard dimensions for wall mount kits are shown in the table below.

Unit: mm (inches)

Model name	VESA screw hole specs (A * B) in millimeters	Standard Screw	Quantity
SH37F	400 x 200 (15.7 x 7.9)	M8 / L14 - 16	4

— Do not install your Wall Mount Kit while your product is turned on. It may result in personal injury due to electric shock.

Remote Control (RS232C)

Cable Connection

RS232C Cable

Interface	RS232C (9 pins)
Pin	TxD (No.2), RxD (No.3), GND (No.5)
Bit rate	9600 bps
Data bits	8 bit
Parity	None
Stop bit	1 bit
Flow control	None
Maximum length	15 m (only shielded type)

- Pin assignment

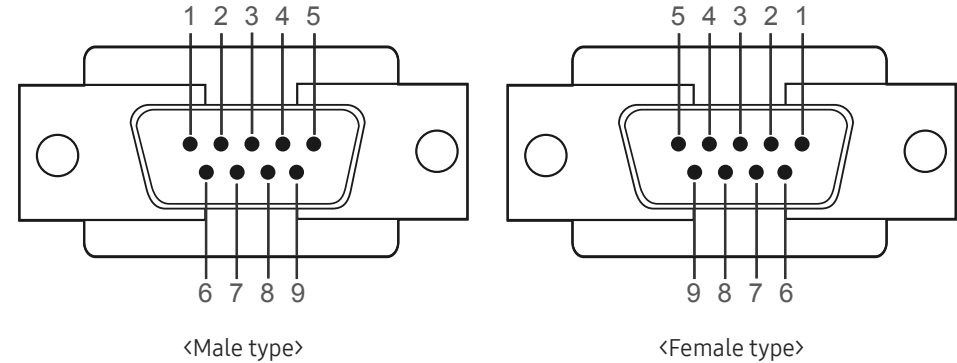

Pin	Signal
1	Detect data carrier
2	Received data
3	Transmitted data
4	Prepare data terminal
5	Signal ground
6	Prepare data set
7	Send request
8	Clear to send
9	Ring indicator

- RS232C cable
Connector: 9-Pin D-Sub to Stereo Cable

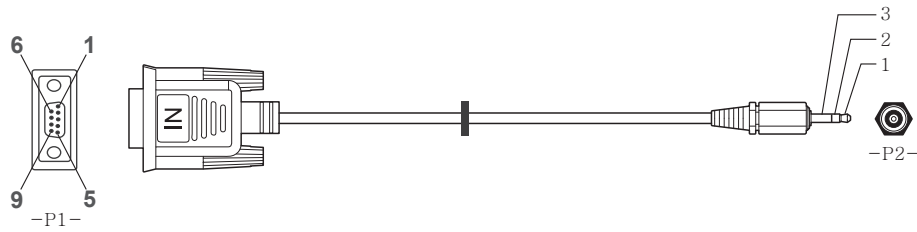

-P1-		-P1-		-P2-		-P2-	
Male type	Rx	3	-----	2	Tx	STEREO	
	Tx	2	-----	1	Rx	PLUG	
	Gnd	5	-----	3	Gnd	(3.5ø)	

LAN Cable

- Pin assignment

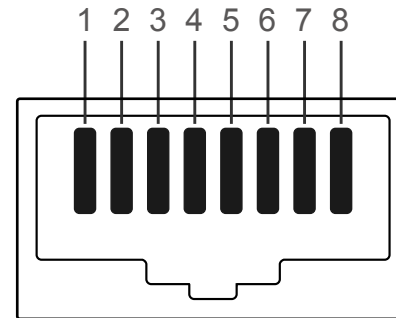

Pin No	Standard Color	Signal
1	White and orange	TX+
2	Orange	TX-
3	White and green	RX+
4	Blue	NC
5	White and blue	NC
6	Green	RX-
7	White and brown	NC
8	Brown	NC

- Connector : RJ45

Direct LAN cable (PC to HUB)

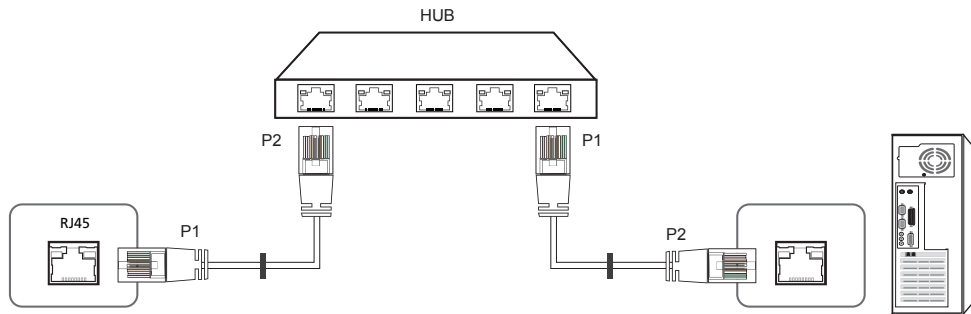

Signal	P1		P2	Signal
TX+	1	<----->	1	TX+
TX-	2	<----->	2	TX-
RX+	3	<----->	3	RX+
RX-	6	<----->	6	RX-

Cross LAN cable (PC to PC)

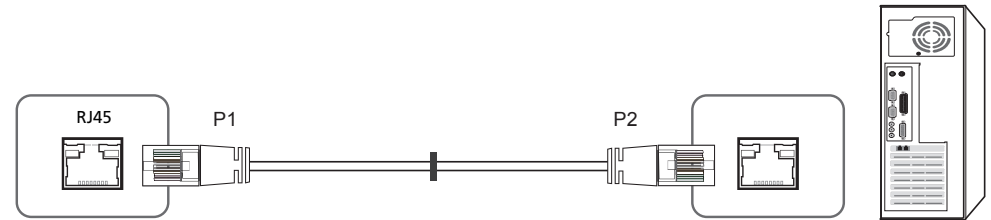

Signal	P1		P2	Signal
TX+	1	<----->	3	RX+
TX-	2	<----->	6	RX-
RX+	3	<----->	1	TX+
RX-	6	<----->	2	TX-

Connection

— Ensure you connect each of the adapters to the correct RS232C IN or OUT port on the product.

- Connection 1

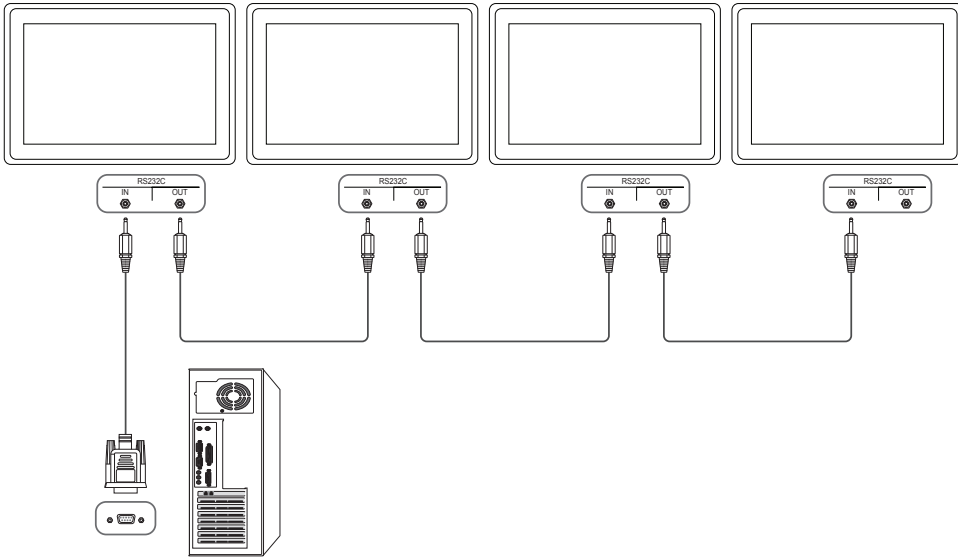

- Connection 2

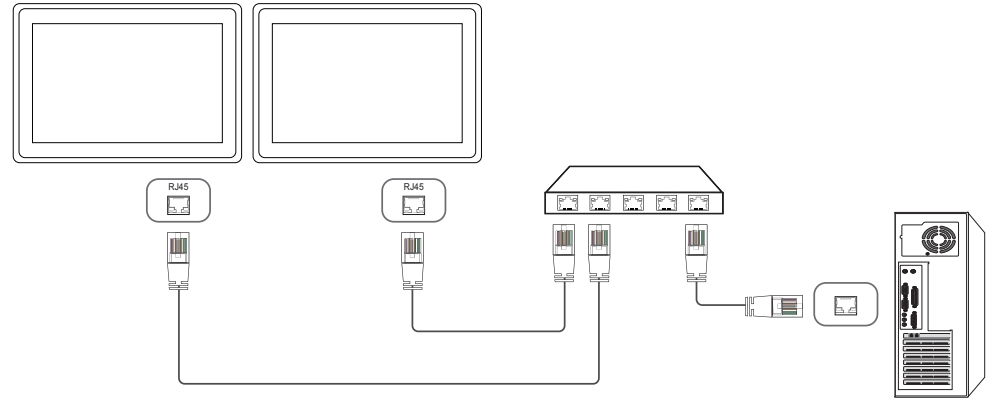

- Connection 3

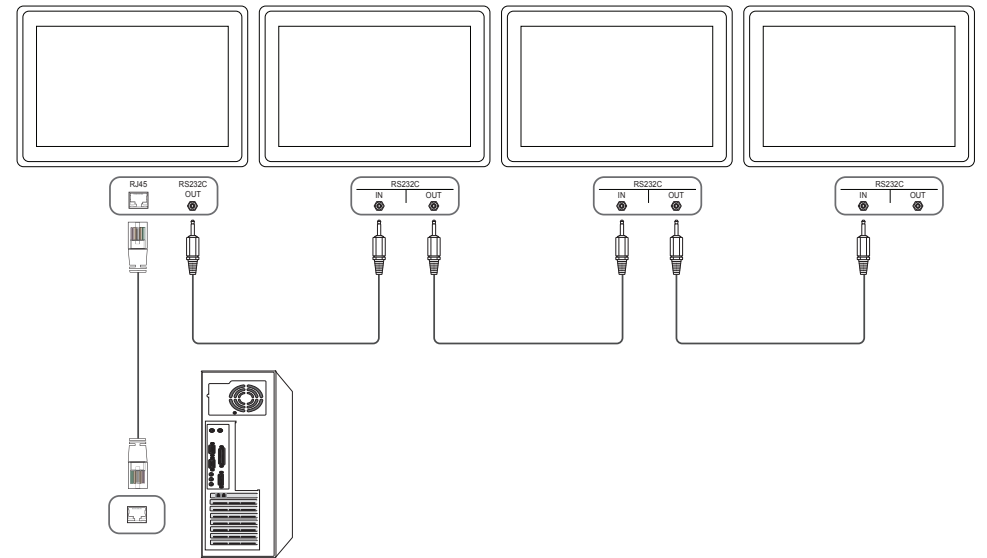

Control Codes

Viewing control state (Get control command)

Header	Command	ID	Data length	Checksum
0xAA	Command type		0	

Controlling (Set control command)

Header	Command	ID	Data length	Data	Checksum
0xAA	Command type		1	Value	

Command

No.	Command type	Command	Value range
1	Power control	0x11	0~1
2	Volume control	0x12	0~100
3	Input source control	0x14	-
4	Screen mode control	0x18	-
5	Screen size control	0x19	0~255
6	PIP on/off control	0x3C	0~1
7	Auto adjustment control (PC and BNC only)	0x3D	0
8	Video wall mode control	0x5C	0~1
9	Safety Lock	0x5D	0~1
10	Video Wall On	0x84	0~1

No.	Command type	Command	Value range
11	Video Wall User Control	0x89	-

- All communications take place in hexadecimal. The checksum is calculated by adding up all values except the header. If a checksum adds up to be more than 2 digits as shown below (11+FF+01+01=112), the first digit is removed.

E.g. Power On & ID=0

Header	Command	ID	Data length	Data 1	Checksum
0xAA	0x11		1	"Power"	

Header	Command	ID	Data length	Data 1	Checksum
0xAA	0x11		1	1	12

- To control all devices connected by a serial cable simultaneously irrespective of IDs, set the ID as "0xFE" and transmit commands. Commands will be executed by each device but ACK will not respond.

Power control

- Function
A product can be powered on and off using a PC.
- Viewing power state (Get Power ON / OFF Status)

Header	Command	ID	Data length	Checksum
0xAA	0x11		0	

- Setting power ON/Off (Set Power ON / OFF)

Header	Command	ID	Data length	Data	Checksum
0xAA	0x11		1	"Power"	

"Power": Power code to be set on a product.

1: Power ON

0: Power OFF

- Ack

Header	Command	ID	Data length	Ack/Nak	r-CMD	Val1	Checksum
0xAA	0xFF		3	'A'	0x11	"Power"	

"Power": Power code to be set on a product.

- Nak

Header	Command	ID	Data length	Ack/Nak	r-CMD	Val1	Checksum
0xAA	0xFF		3	'N'	0x11	"ERR"	

"ERR" : A code showing what error has occurred.

Volume control

- Function
The volume of a product can be adjusted using a PC.
- Viewing volume state (Get Volume Status)

Header	Command	ID	Data length	Checksum
0xAA	0x12		0	

- Setting the volume (Set Volume)

Header	Command	ID	Data length	Data	Checksum
0xAA	0x12		1	"Volume"	

"Volume": Volume value code to be set on a product. (0-100)

- Ack

Header	Command	ID	Data length	Ack/Nak	r-CMD	Val1	Checksum
0xAA	0xFF		3	'A'	0x12	"Volume"	

"Volume": Volume value code to be set on a product. (0-100)

- Nak

Header	Command	ID	Data length	Ack/Nak	r-CMD	Val1	Checksum
0xAA	0xFF		3	'N'	0x12	"ERR"	

"ERR" : A code showing what error has occurred.

Input source control

- Function
The input source of a product can be changed using a PC.
- Viewing input source state (Get Input Source Status)

Header	Command	ID	Data length	Checksum
0xAA	0x14		0	

- Setting the input source (Set Input Source)

Header	Command	ID	Data length	Data	Checksum
0xAA	0x14		1	"Input Source"	

"Input Source": An input source code to be set on a product.

0x14	PC
0x18	DVI
0x0C	Input source
0x20	MagicInfo
0x1F	DVI_video
0x21	HDMI1
0x22	HDMI1_PC
0x23	HDMI2
0x24	HDMI2_PC
0x25	DisplayPort

- DVI_video, HDMI1_PC and HDMI2_PC cannot be used with the Set command. They only respond to "Get" commands.
- This model does not support HDMI1, HDMI1_PC, HDMI2 and HDMI2_PC ports.
- **MagicInfo** is only available with models that contain the **MagicInfo** function.

- Ack

Header	Command	ID	Data length	Ack/Nak	r-CMD	Val1	Checksum
0xAA	0xFF		3	'A'	0x14	"Input Source"	

"Input Source": An input source code to be set on a product.

- Nak

Header	Command	ID	Data length	Ack/Nak	r-CMD	Val1	Checksum
0xAA	0xFF		3	'N'	0x14	"ERR"	

"ERR" : A code showing what error has occurred.

Screen mode control

- **Function**
The screen mode of a product can be changed using a PC.
Screen mode cannot be controlled when the **Video Wall** function is enabled.
- **Viewing screen status (Get Screen Mode Status)**

Header	Command	ID	Data length	Checksum
0xAA	0x18		0	

- **Setting the picture size (Set Picture Size)**

Header	Command	ID	Data length	Data	Checksum
0xAA	0x18		1	"Screen Mode"	

"Screen Mode": A code that sets the product status

0x01	16 : 9
0x04	Zoom
0x31	Wide Zoom
0x0B	4 : 3

- **Ack**

Header	Command	ID	Data length	Ack/Nak	r-CMD	Val1	Checksum
0xAA	0xFF		3	'A'	0x18	"Screen Mode"	

"Screen Mode": A code that sets the product status

- **Nak**

Header	Command	ID	Data length	Ack/Nak	r-CMD	Val1	Checksum
0xAA	0xFF		3	'N'	0x18	"ERR"	

"ERR": A code showing what error has occurred

Screen size control

- **Function**
The screen size of a product can be changed using a PC.
- **Viewing the screen size (Get Screen Size Status)**

Header	Command	ID	Data length	Checksum
0xAA	0x19		0	

- **Ack**

Header	Command	ID	Data length	Ack/Nak	r-CMD	Val1	Checksum
0xAA	0xFF		3	'A'	0x19	"Screen Size"	

"Screen Size": product screen size (range: 0 – 255, unit: inch)

- **Nak**

Header	Command	ID	Data length	Ack/Nak	r-CMD	Val1	Checksum
0xAA	0xFF		3	'N'	0x19	"ERR"	

"ERR": A code showing what error has occurred

PIP On/Off control

- **Function**
The PIP mode of a product can be turned on or off using a PC.
 - ▭ Only available on models that have the PIP function.
 - ▭ The mode cannot be controlled if **Video Wall** is set to **On**.
 - ▭ This function is not available in **MagicInfo**.
- **Viewing PIP on/off state (Get the PIP ON / OFF Status)**

Header	Command	ID	Data length	Checksum
0xAA	0x3C		0	

- **Setting PIP on/off (Set the PIP ON / OFF)**

Header	Command	ID	Data length	Data	Checksum
0xAA	0x3C		1	"PIP"	

"PIP": A code used to turn the PIP mode of a product on or off

1: PIP ON

0: PIP OFF

- **Ack**

Header	Command	ID	Data length	Ack/Nak	r-CMD	Val1	Checksum
0xAA	0xFF		3	'A'	0x3C	"PIP"	

"PIP": A code used to turn the PIP mode of a product on or off

- **Nak**

Header	Command	ID	Data length	Ack/Nak	r-CMD	Val1	Checksum
0xAA	0xFF		3	'A'	0x3C	"PIP"	

"ERR": A code showing what error has occurred

Auto adjustment control (PC and BNC only)

- **Function**
Automatically adjust the PC system screen using a PC.
- **Viewing auto adjustment state (Get Auto Adjustment Status)**
None
- **Setting auto adjustment (Set Auto Adjustment)**

Header	Command	ID	Data length	Data	Checksum
0xAA	0x3D		1	"Auto Adjustment"	

"Auto Adjustment" : 0x00 (at all times)

- **Ack**

Header	Command	ID	Data length	Ack/Nak	r-CMD	Val1	Checksum
0xAA	0xFF		3	'A'	0x3D	"Auto Adjustment"	

- **Nak**

Header	Command	ID	Data length	Ack/Nak	r-CMD	Val1	Checksum
0xAA	0xFF		3	'A'	0x3D	"ERR"	

"ERR": A code showing what error has occurred

Video Wall Mode Control

- Function
Video Wall mode can be activated on a product using a PC.
This control is only available on a product whose Video Wall is enabled.
- Viewing video wall mode (Get Video Wall Mode)

Header	Command	ID	Data length	Checksum
0xAA	0x5C		0	

- Setting the video wall (Set Video Wall Mode)

Header	Command	ID	Data length	Data	Checksum
0xAA	0x5C		1	"Video Wall Mode"	

"Video Wall Mode": A code used to activate Video Wall mode on a product

1: Full

0: Natural

- Ack

Header	Command	ID	Data length	Ack/Nak	r-CMD	Val1	Checksum
0xAA	0xFF		3	'A'	0x5C	"Video Wall Mode"	

"Video Wall Mode": A code used to activate Video Wall mode on a product

- Nak

Header	Command	ID	Data length	Ack/Nak	r-CMD	Val1	Checksum
0xAA	0xFF		3	'A'	0x5C	"ERR"	

"ERR": A code showing what error has occurred

Safety Lock

- Function
PC can be used to turn the Safety Lock function on or off on a product.
This control is available regardless of whether or not the power is turned on.
- Viewing the safety lock state (Get Safety Lock Status)

Header	Command	ID	Data length	Checksum
0xAA	0x5D		0	

- Enabling or disabling safety lock (Set Safety Lock Enable / Disable)

Header	Command	ID	Data length	Data	Checksum
0xAA	0x5D		1	"Safety Lock"	

"Safety Lock": Safety lock code to be set on a product

1: ON

0: OFF

- Ack

Header	Command	ID	Data length	Ack/Nak	r-CMD	Val1	Checksum
0xAA	0xFF		3	'A'	0x5D	"Safety Lock"	

"Safety Lock": Safety lock code to be set on a product

- Nak

Header	Command	ID	Data length	Ack/Nak	r-CMD	Val1	Checksum
0xAA	0xFF		3	'N'	0x5D	"ERR"	

"ERR": A code showing what error has occurred

Video Wall On

- Function
Turn Video Wall on or off on the product from your computer.
- Get Video Wall On/Off Status

Header	Command	ID	Data length	Checksum
0xAA	0x84		0	

- Set Video Wall On/Off

Header	Command	ID	Data length	Data	Checksum
0xAA	0x84		1	V.Wall_On	

- V.Wall_On: Video Wall code to be assigned to the product

1: Video Wall ON

0: Video Wall OFF

- Ack

Header	Command	ID	Data length	Ack/Nak	r-CMD	Val1	Checksum
0xAA	0xFF		3	'A'	0x84	V.Wall_On	

V.Wall_On : Same as above

- Nak

Header	Command	ID	Data length	Ack/Nak	r-CMD	Val1	Checksum
0xAA	0xFF		3	'N'	0x84	ERR	

"ERR": A code showing what error has occurred

Video Wall User Control

- Function
Turn the Video Wall function on or off on the product from your computer.
- Get Video Wall Status

Header	Command	ID	Data length	Checksum
0xAA	0x89		0	

- Set Video Wall

Header	Command	ID	Data length	Val1	Val2	Checksum
0xAA	0x89		2	Wall_Div	Wall_SNo	

Wall_Div: Video Wall Divider code assigned to the product

10x10 Video Wall Model

	1	2	3	4	5	6	7	8	9	10	11	12	13	14	15
Off	0x00	0x00	0x00	0x00	0x00	0x00	0x00	0x00	0x00	0x00	0x00	0x00	0x00	0x00	0x00
1	0x11	0x12	0x13	0x14	0x15	0x16	0x17	0x18	0x19	0x1A	0x1B	0x1C	0x1D	0x1E	0x1F
2	0x21	0x22	0x23	0x24	0x25	0x26	0x27	0x28	0x29	0x2A	0x2B	0x2C	0x2D	0x2E	0x2F
3	0x31	0x32	0x33	0x34	0x35	0x36	0x37	0x38	0x39	0x3A	0x3B	0x3C	0x3D	0x3E	0x3F
4	0x41	0x42	0x43	0x44	0x45	0x46	0x47	0x48	0x49	0x4A	0x4B	0x4C	0x4D	0x4E	0x4F
5	0x51	0x52	0x53	0x54	0x55	0x56	0x57	0x58	0x59	0x5A	0x5B	0x5C	0x5D	0x5E	0x5F
6	0x61	0x62	0x63	0x64	0x65	0x66	0x67	0x68	0x69	0x6A	0x6B	0x6C	0x6D	0x6E	0x6F
7	0x71	0x72	0x73	0x74	0x75	0x76	0x77	0x78	0x79	0x7A	0x7B	0x7C	0x7D	0x7E	N/A
8	0x81	0x82	0x83	0x84	0x85	0x86	0x87	0x88	0x89	0x8A	0x8B	0x8C	N/A	N/A	N/A
9	0x91	0x92	0x93	0x94	0x95	0x96	0x97	0x98	0x99	0x9A	0x9B	N/A	N/A	N/A	N/A
10	0xA1	0xA2	0xA3	0xA4	0xA5	0xA6	0xA7	0xA8	0xA9	0xAA	N/A	N/A	N/A	N/A	N/A
11	0xB1	0xB2	0xB3	0xB4	0xB5	0xB6	0xB7	0xB8	0xB9	N/A	N/A	N/A	N/A	N/A	N/A
12	0xC1	0xC2	0xC3	0xC4	0xC5	0xC6	0xC7	0xC8	N/A	N/A	N/A	N/A	N/A	N/A	N/A
13	0xD1	0xD2	0xD3	0xD4	0xD5	0xD6	0xD7	N/A	N/A	N/A	N/A	N/A	N/A	N/A	N/A
14	0xE1	0xE2	0xE3	0xE4	0xE5	0xE6	0xE7	N/A	N/A	N/A	N/A	N/A	N/A	N/A	N/A
15	0xF1	0xF2	0xF3	0xF4	0xF5	0xF6	N/A	N/A	N/A	N/A	N/A	N/A	N/A	N/A	N/A

Wall_SNo: Product Number code assigned to the product

10x10 Video Wall Model : (1 ~ 100)

Set Number	Data
1	0x01
2	0x02
...	...
99	0x63
100	0x64

- Ack

Header	Command	ID	Data length	Ack/Nak	r-CMD	Val1	Val2	Checksum
0xAA	0xFF		4	'A'	0x89	Wall_Div	Wall_SNo	

- Nak

Header	Command	ID	Data length	Ack/Nak	r-CMD	Val1	Checksum
0xAA	0xFF		3	'N'	0x89	ERR	

"ERR": A code showing what error has occurred

Chapter 03

Connecting and Using a Source Device

Before Connecting

Pre-connection Checkpoints

- Before connecting a source device, read the user manual provided with it.
The number and locations of ports on source devices may differ from device to device.
- Do not connect the power cable until all connections are completed.
Connecting the power cable during connection may damage the product.
- Connect the sound ports correctly: left = white and right = red.
- Check the types of ports at the back of the product you want to connect.

Connecting to a PC

- Do not connect the power cable before connecting all other cables.
Ensure you connect a source device first before connecting the power cable.
- A PC can be connected to the product in a variety of ways.
Select a connection method suitable for your PC.
- Connecting parts may differ in different products.

Connection using the DVI-RGB cable

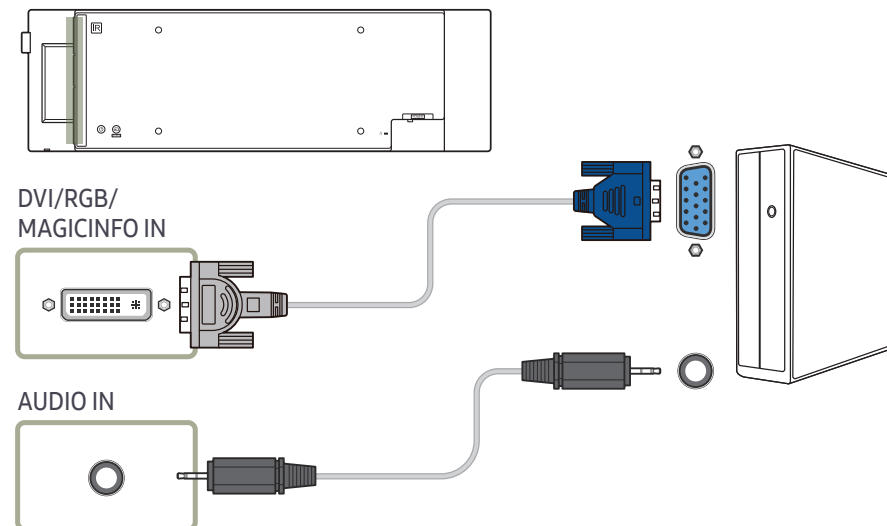

Connection using a DVI cable (Digital type)

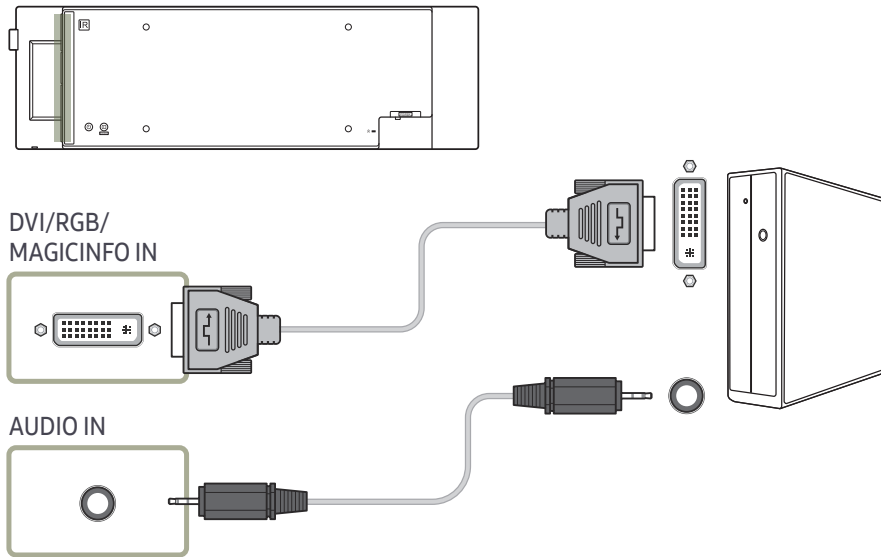

— You can use the DVI port on the product as an HDMI port by using a DVI-HDMI adapter.

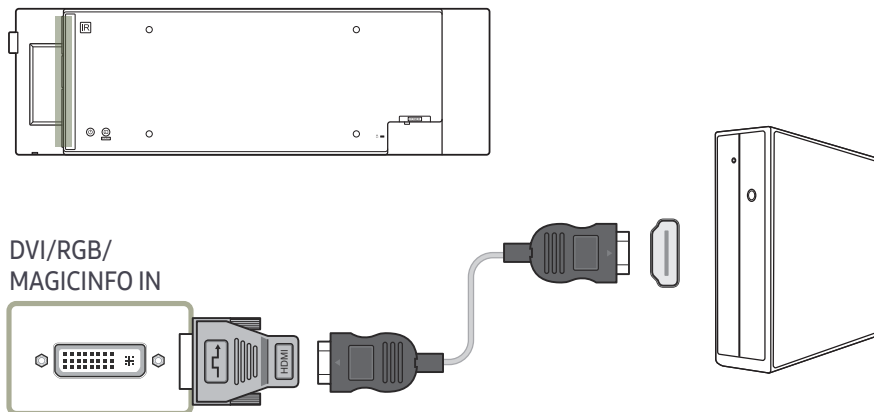

Connection Using an HDMI-DVI Cable

After connecting a computer to the product with an HDMI-DVI cable, make sure to configure the settings as shown below to enable the video and audio from the computer.

- **Sound** → set **HDMI Sound** to **PC(DVI)**
- **Picture** → set each screen mode to **Text** under **Picture Mode**
- **System** → **General** → set **HDMI Hot Plug** to **Off**

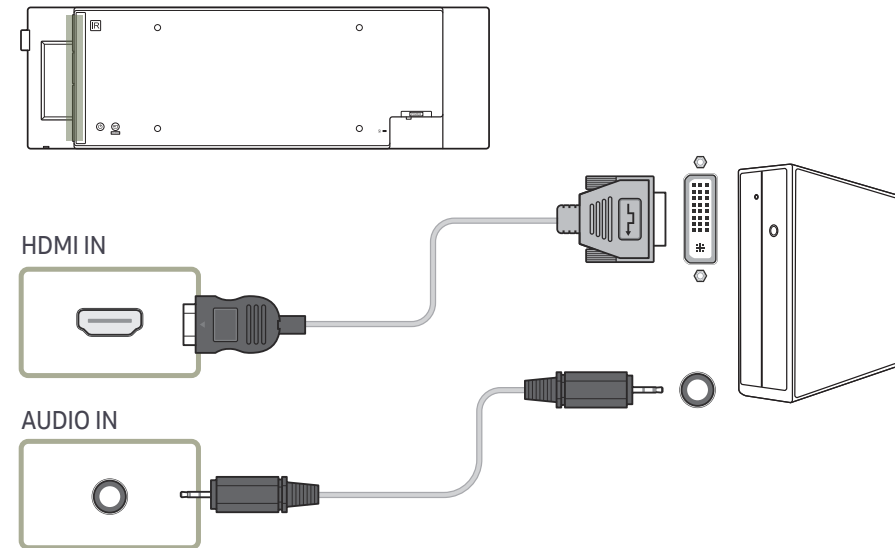

Connection Using an HDMI Cable

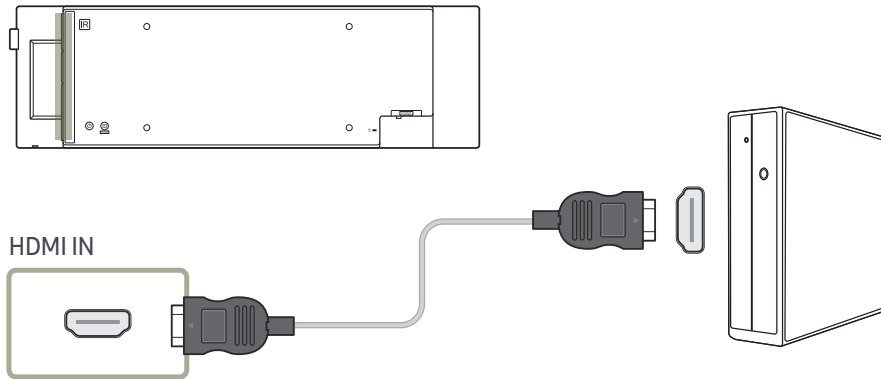

Connection Using an DP Cable

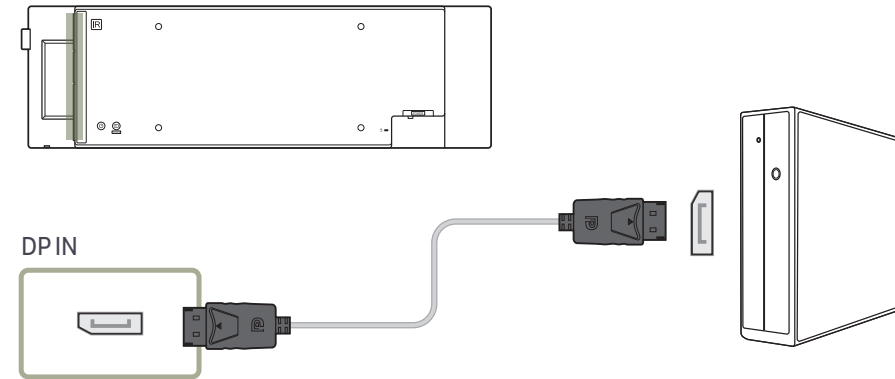

- Precautions for using DP

- To increase the standby power capacity, the product stops DP communication when it is turned off or in power-saving mode.
If the product in dual monitor mode is turned off or goes into power-saving mode, monitor setting changes may not be updated. As a result, screen output may not be displayed properly.
In the occurrence of this issue, set **Max. Power Saving** to **Off** before using the product.
- Some graphics cards that are not compliant with the DP standard may prevent the Windows Booting/Bios screen from being displayed when the product is in power-saving mode. If this is the case, make sure to turn on the product first before turning on your PC.
- The DisplayPort interface (DP IN) on the product and the provided DP cable are designed based on the VESA standards. Using a DP cable that is not VESA compliant may cause the product to function improperly. Samsung Electronics shall not be held responsible for any issues from using a cable that is not VESA compliant.
Make sure to use a DP cable that is VESA compliant.

Connecting an External Monitor

- Do not connect the power cable before connecting all other cables.
Ensure you connect a source device first before connecting the power cable.
- Connecting parts may differ in different products.
- The DAISY CHAIN port is only available when the input source is **PC, DVI, HDMI** (PC connection), **DisplayPort, MagicInfo** or **MagicInfo S**.
- When you play content using **Player** (MagicInfo S) on the home screen, Loopout is supported only for images. It is not supported for voice.

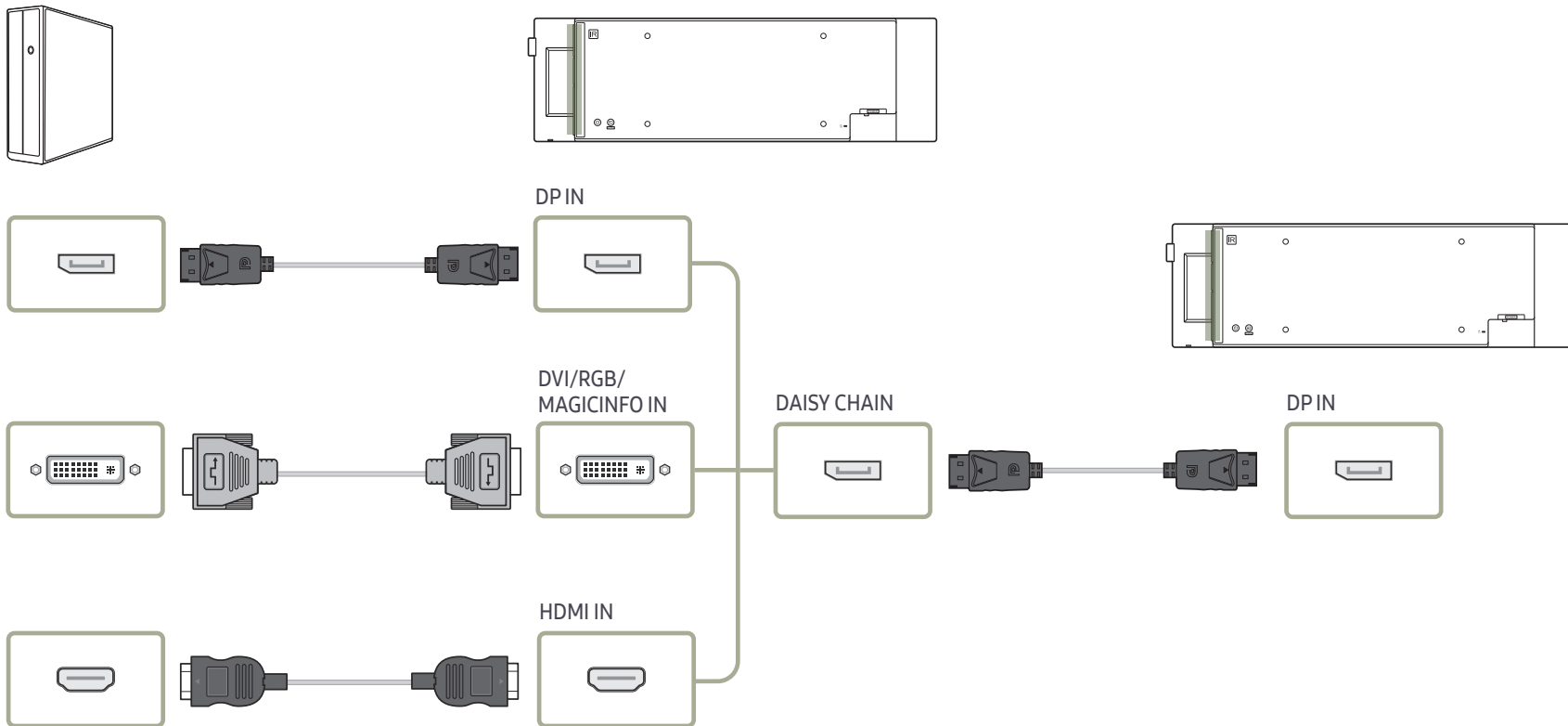

Connecting to a Video Device

- Do not connect the power cable before connecting all other cables.
Ensure you connect a source device first before connecting the power cable.
- You can connect a video device to the product using a cable.
 - Connecting parts may differ in different products.
 - Press the **SOURCE** button on the remote control to change the source.

Connection Using an HDMI-DVI Cable

- Audio will not be enabled if the product is connected to a video device using an HDMI-DVI cable. To resolve this, additionally connect an audio cable to the audio ports on the product and video device.
- After connecting a video device to the product with an HDMI-DVI cable, make sure to configure the settings as shown below to enable the video and audio from the video device. You can use the DVI port on the product as an HDMI port by using a DVI-HDMI adapter.
 - **Sound** → set **HDMI Sound** to **AV(HDMI)**
 - **Picture** → set each screen mode to **Video/Image** under **Picture Mode**
 - **System** → **General** → set **HDMI Hot Plug** to **On**
- Supported resolutions include 1080p (50/60Hz), 720p (50/60Hz), 480p, and 576p.

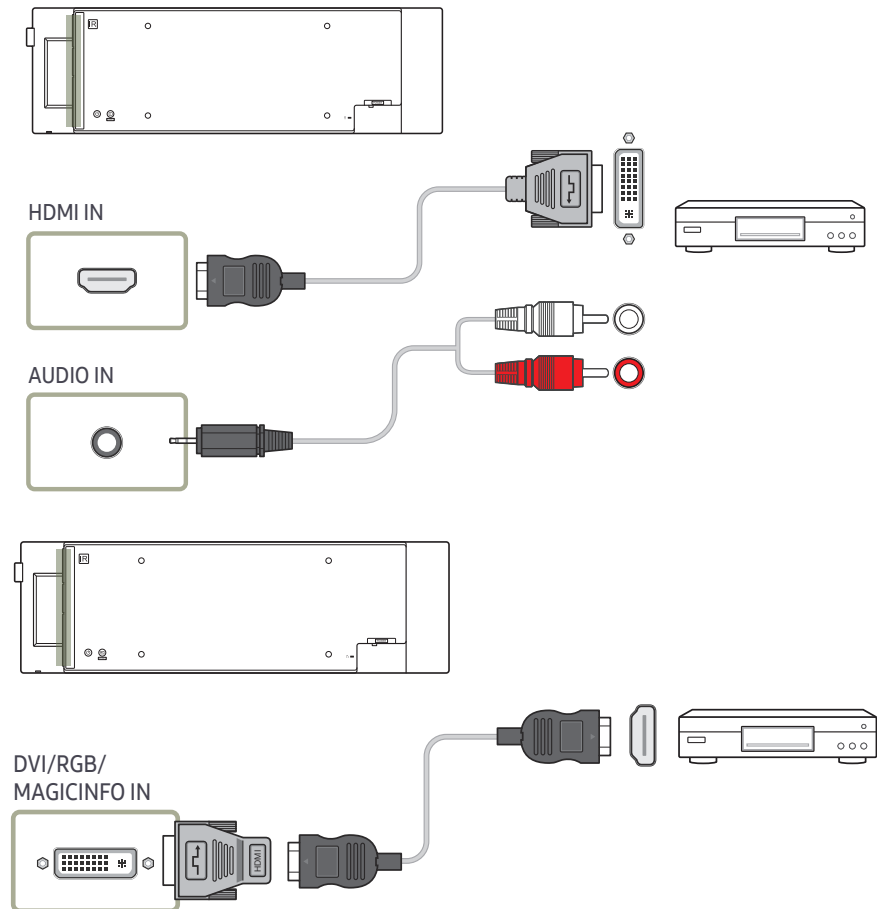

Connection Using an HDMI Cable

Using an HDMI cable or HDMI to DVI Cable (up to 1080p)

- For better picture and audio quality, connect to a digital device using an HDMI cable.
- An HDMI cable supports digital video and audio signals, and does not require an audio cable.
 - To connect the product to a digital device that does not support HDMI output, use an HDMI-DVI and audio cables.
- The picture may not display normally (if at all) or the audio may not work if an external device that uses an older version of HDMI mode is connected to the product. If such a problem occurs, ask the manufacturer of the external device about the HDMI version and, if out of date, request an upgrade.
- Be sure to use an HDMI cable with a thickness of 14 mm or less.
- Be sure to purchase a certified HDMI cable. Otherwise, the picture may not display or a connection error may occur.
- A basic high-speed HDMI cable or one with ethernet is recommended. This product does not support the ethernet function via HDMI.

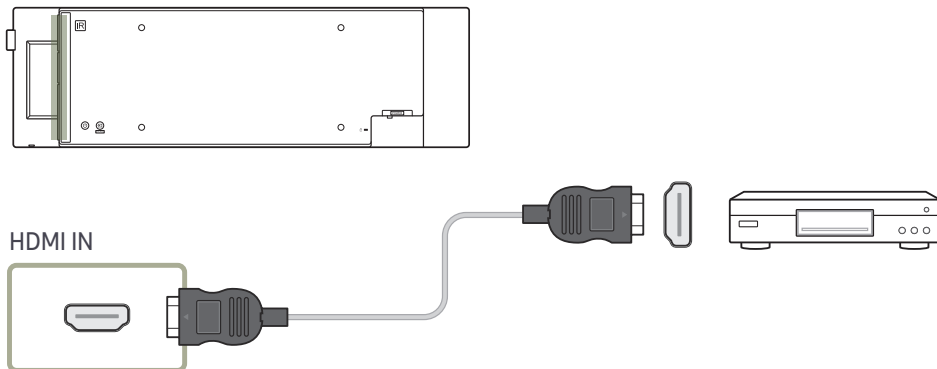

Connecting to an Audio System

— Connecting parts may differ in different products.

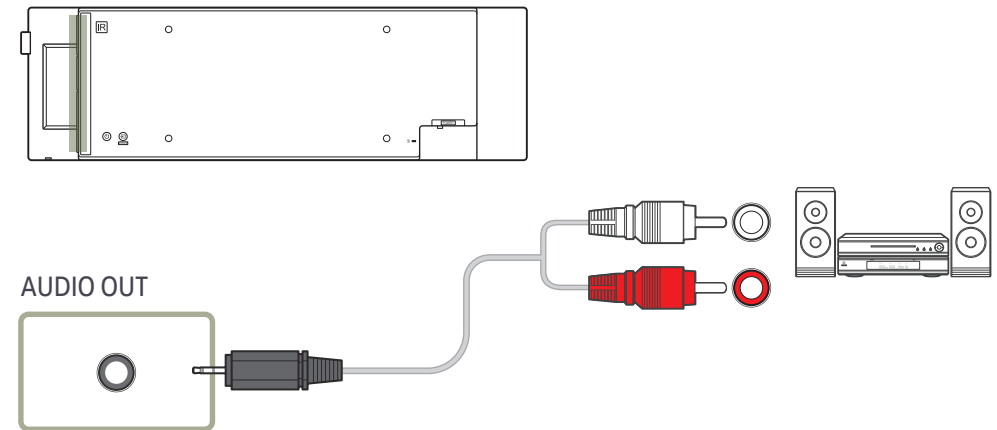

Connecting the LAN Cable

Connecting parts may differ in different products.

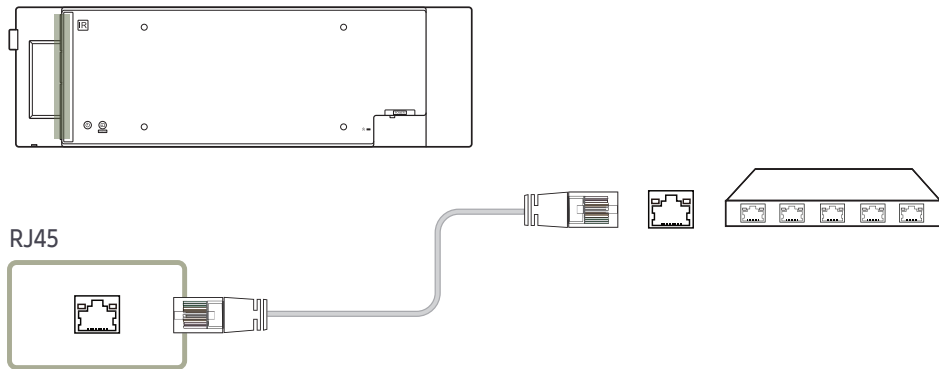

- Use Cat7(*STP Type) cable for the connection.
*Shielded Twist Pair.

Changing the Input source

Source

SOURCE → Source

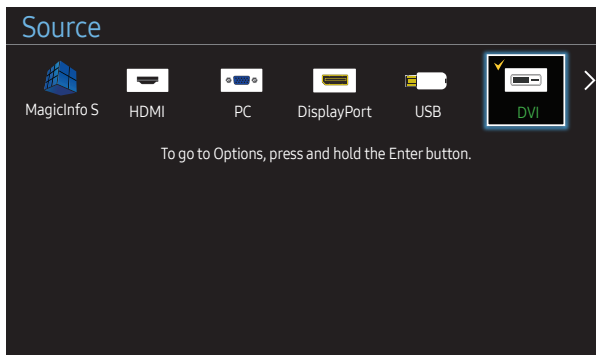

– The displayed image may differ depending on the model.

Source allows you to select a variety of sources and change source device names.

You can display the screen of a source device connected to the product. Select a source from source list to display the screen of the selected source.

- The input source can also be changed by using the **SOURCE** button on the remote control.
- The screen may not display correctly if an incorrect source is selected for the source device you want to convert to.
- To view detailed information about connected source devices, press the **TOOLS** button from the **Source** page.

Edit Name

SOURCE → Source → TOOLS → Edit Name → ENTER

Customize the name of a connected external device.

- The list can include the following source devices. **Source** devices on the list differ depending on the selected source.

PC / Cable STB / Satellite STB / PVR STB / Game / Blu-ray / DVD / VCR / AV Receiver / Camcorder / DVI PC / DVI Devices / TV / IPTV / HD DVD / DMA

Information

SOURCE → Source → TOOLS → Information → ENTER

You can see detailed information about the selected external device.

Chapter 04

Using MDC

Multiple display control "MDC" is an application that allows you to easily control multiple display devices simultaneously using a PC.
- For details on how to use the MDC program, refer to Help after installing the program. The MDC program is available on the website.

MDC Program Installation/Uninstallation

Installation

— MDC installation can be affected by the graphics card, mother board and network conditions.

- 1 Click the **MDC Unified** installation program.
- 2 Select a language for installation. Next, click **"OK"**.
- 3 When the **"Welcome to the InstallShield Wizard for MDC_Unified"** screen appears, click **"Next"**.
- 4 In the **"License Agreement"** window displayed, select **"I accept the terms in the license agreement"** and click **"Next"**.
- 5 In the displayed **"Customer Information"** window, fill out all the information fields and click **"Next"**.

- 6 In the displayed **"Destination Folder"** window, select the directory path you want to install the program in and click **"Next"**.
 - If the directory path is not specified, the program will be installed in the default directory path.
- 7 In the displayed **"Ready to Install the Program"** window, check the directory path to install the program in and click **"Install"**.
- 8 Installation progress will be displayed.
- 9 Click **"Finish"** in the displayed **"InstallShield Wizard Complete"** window.
 - Select **"Launch MDC Unified"** and click **"Finish"** to run the MDC program immediately.
- 10 The **MDC Unified** shortcut icon will be created on the desktop after installation.
 - The MDC execution icon may not be displayed depending on the PC system or product specifications.
 - Press F5 if the execution icon is not displayed.

Uninstallation

- 1 Select **Settings > Control Panel** on the **Start** menu and double-click **Add/Delete Program**.
- 2 Select **MDC Unified** from the list and click **Change/Remove**.

Connecting to MDC

Using MDC via RS-232C (serial data communications standards)

An RS-232C serial cable must be connected to the serial ports on the PC and monitor.

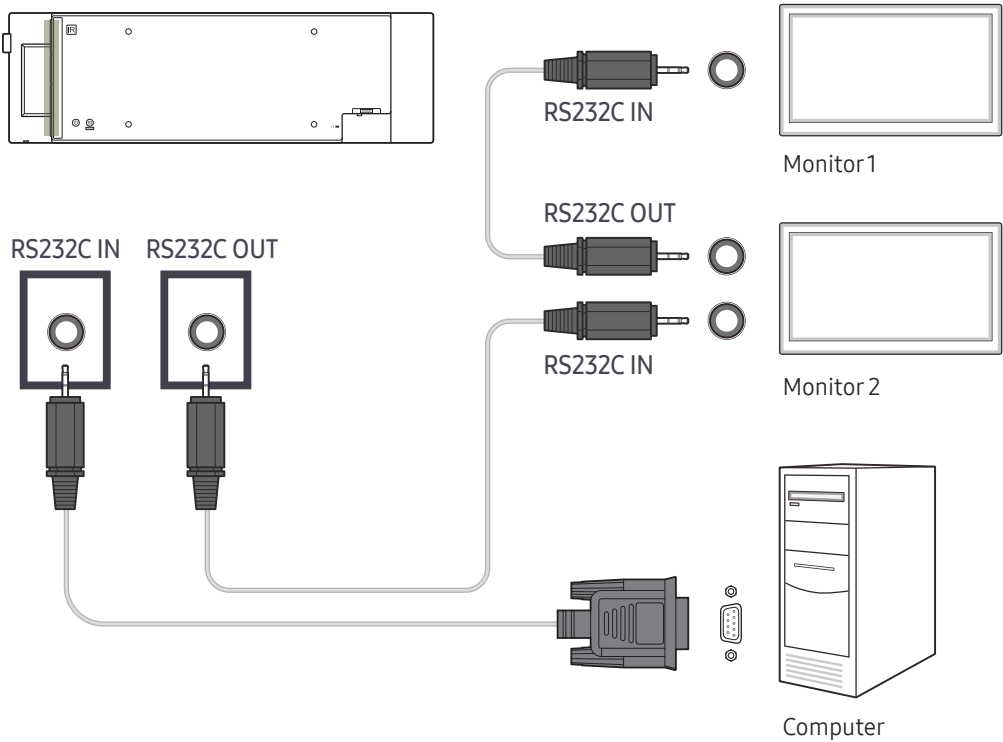

Using MDC via Ethernet

Enter the IP for the primary display device and connect the device to the PC. Display devices can be connected to each other using a LAN cable.

Connection using a direct LAN cable

Multiple products can be connected using the RJ45 port on the product and the LAN ports on the HUB.

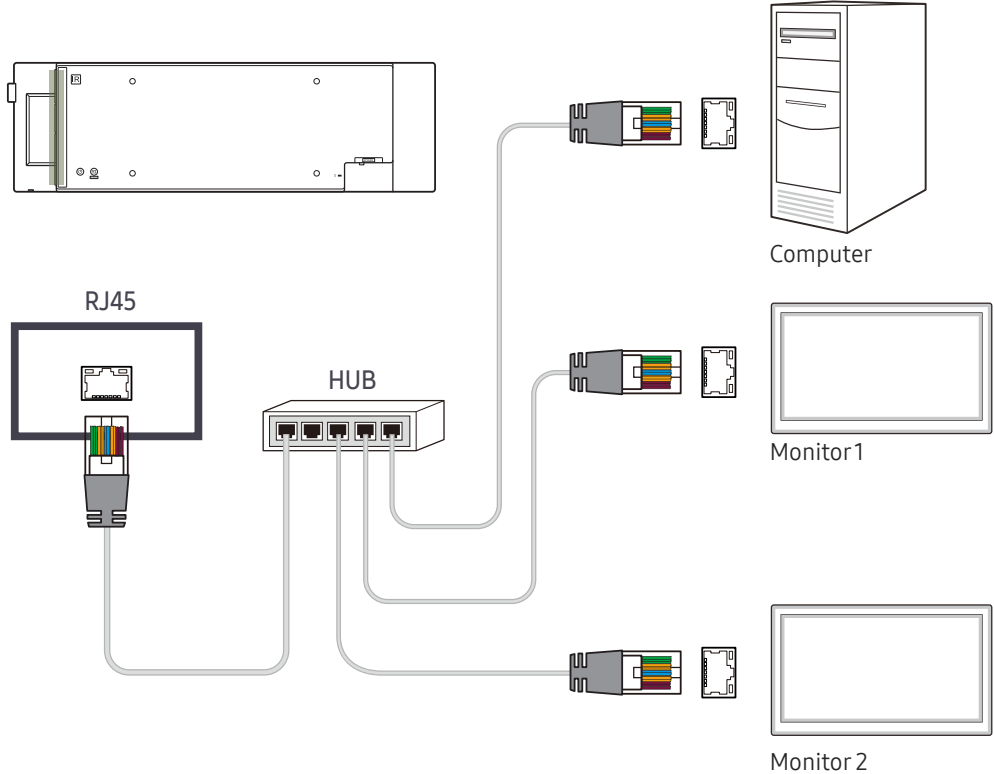

Connection using a cross LAN cable

Multiple products can be connected using the RS232C IN / OUT port on the product.

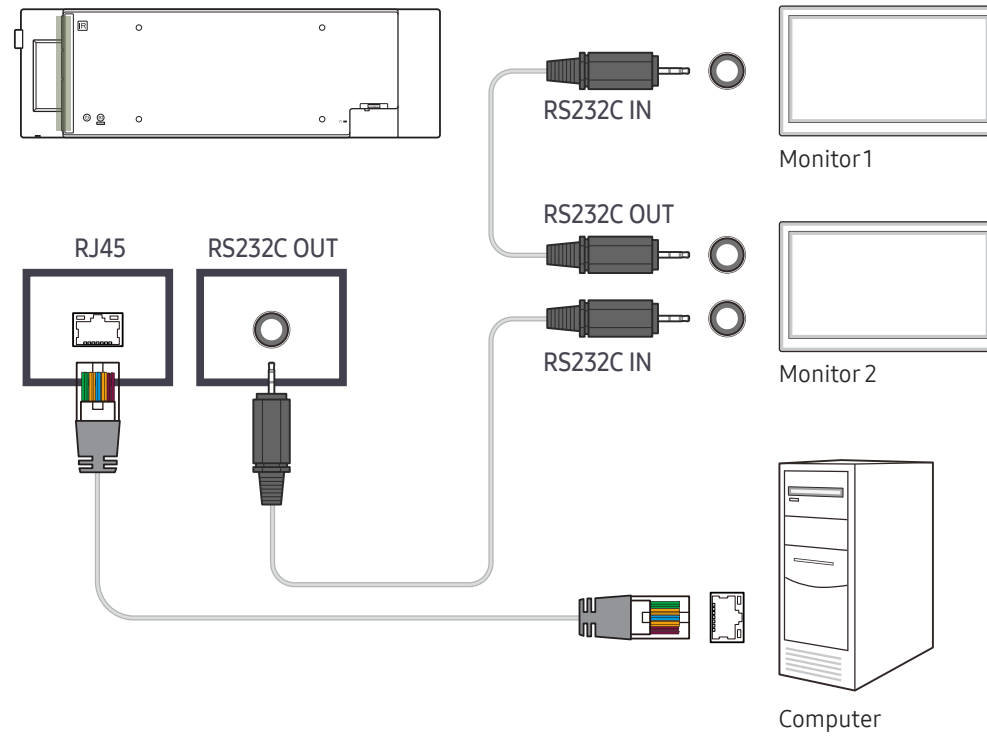

Chapter 05

Home feature

This feature is provided in [Support](#) → [Go to Home](#).

Accessible using the HOME button on the remote control.

Player

HOME  → **Player** → ENTER 

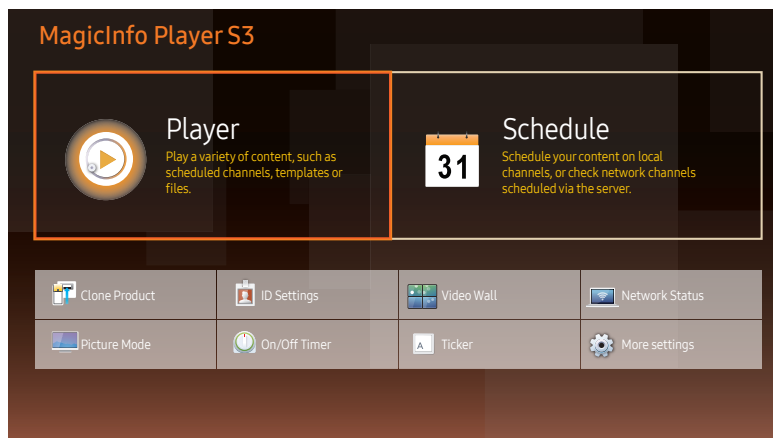

– The displayed image may differ depending on the model.

– To use the **Player** feature, set **Play via** to **MagicInfo** in **System**.

Play a range of content such as channels with schedules assigned, templates or files.

Play channels or content using any of the following methods.

- **Network Channel:** Play content using the server.
 - To run **Network Channel**, make sure the product is connected to the server.
- **Local Channel:** Play content in internal memory or from external memory.

Approving a connected device from the server

Approving the Lite server

- Set **MagicInfo Mode** to **Lite** in **Server Network Settings**.
Approve and use the **Lite** server now.
- First configure the server **Network Settings** before device approval.

1 Access the server you have assigned to your device.



2 Enter your ID and password to log in.

3 Select **Device** from the top menu bar.

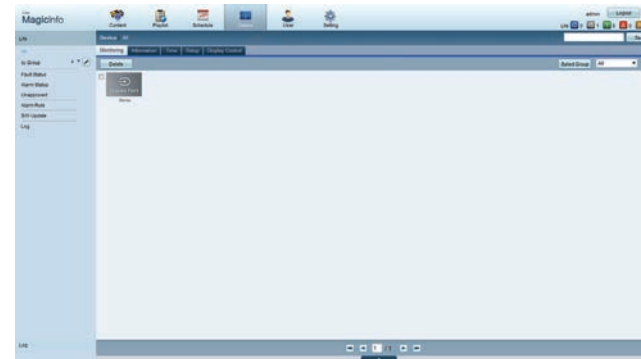

4 Select **Lite** from the menus on the left.

5 Select **Unapproved** from the sub-menus of **Lite**.

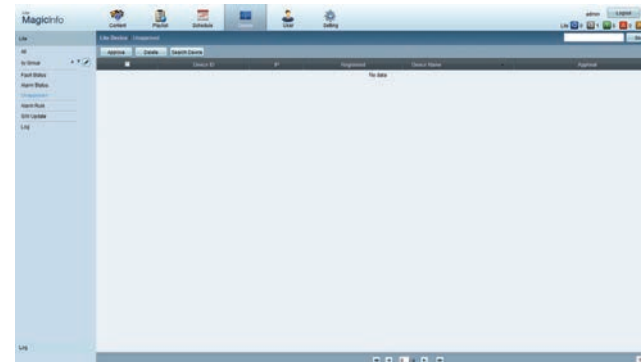

6 Select the **Approve** button for your device from the list of unapproved Lite devices.

7 Enter the information required to approve the device.

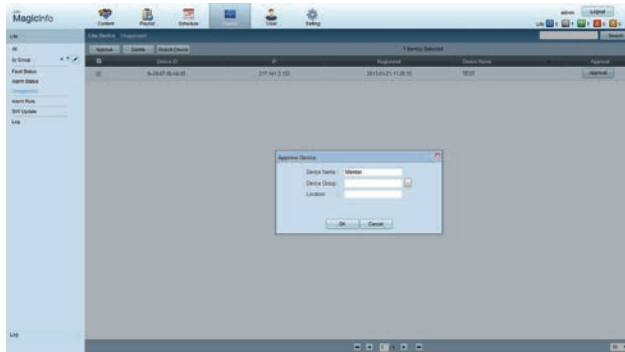

- **Device Name:** Enter the device name.
- **Device Group:** Select to specify the group.
- **Location:** Enter the current location of the device.

Pressing the INFO button on the remote when a network schedule is running will display the details of the schedule. Check that the correct device has been selected by viewing the device ID in the details.

8 Select the **All** menu to check that the device has been registered.

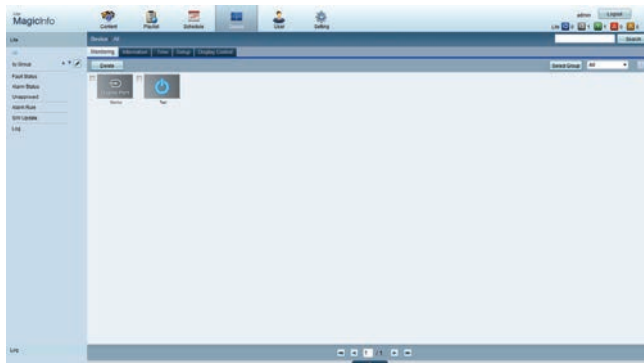

9 When the device is approved by the server, the schedule registered in the selected group will be downloaded to the device. The schedule will run after it is downloaded.

- For further details on how to configure a schedule, refer to the <MagicInfo Lite Server user's manual>.
- If a device is deleted from the list of devices approved by the server, the device will reboot to reset its settings.

Setting the current time

A schedule may not run if the time set on the device is different from the server's current time.

1 Go to the tabs **Device** → **Time**.

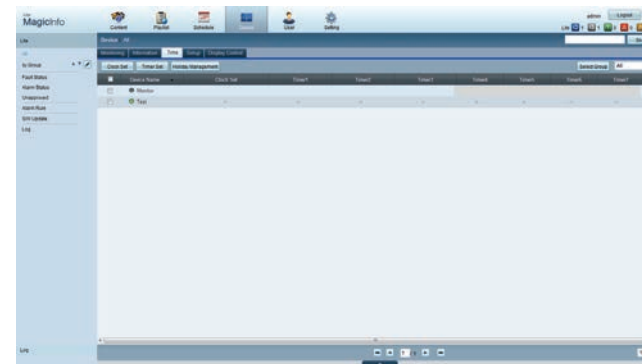

2 Select your device.

3 Select **Clock Set**, and sync the time with the server.

- When connecting to the server for the first time, the time on the product is set using the GMT time of the region where the server is installed.
 - The time on the product can be changed from the server as shown in step 3.
 - Turning the product off and then on again will restore the time setting on the product to the last time that was set from the server.
- For further details on how to manage the time (scheduling, holiday management, etc.), refer to the <MagicInfo Lite Server user's manual>.

Approving the Premium server

- Set **MagicInfo Mode** to **Premium** in **Server Network Settings**.
Approve and use the **Premium** server now.
- First configure the server **Network Settings** before device approval.

1 Access the server you have assigned to your device.

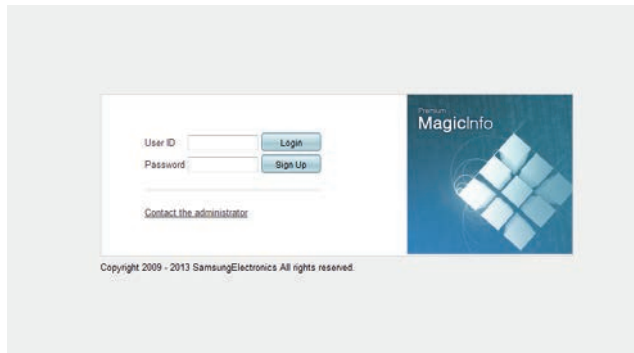

2 Enter your ID and password to log in.

3 Select **Device** from the top menu bar.

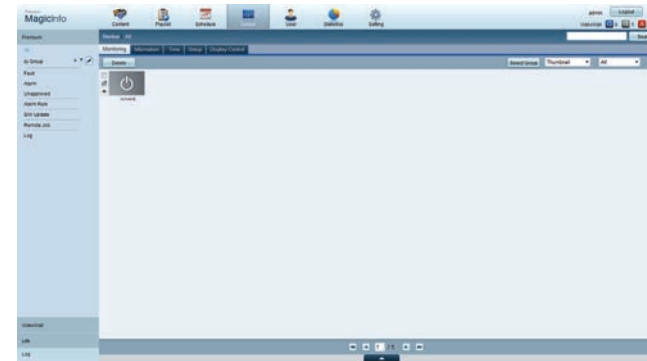

4 Select **Premium** from the menus on the left.

5 Select **Unapproved** from the sub-menus of **Premium**.

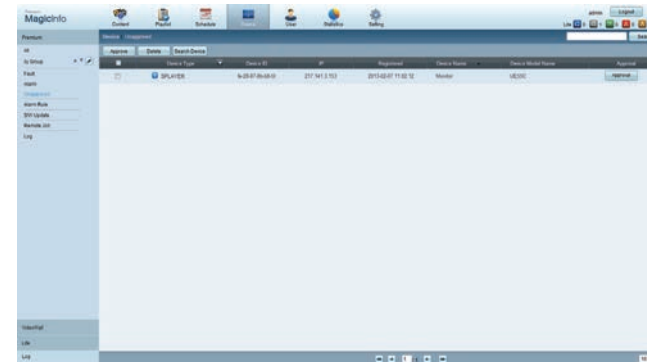

6 Select the **Approve** button for your device from the list of unapproved Premium devices.

7 Enter the information required to approve the device.

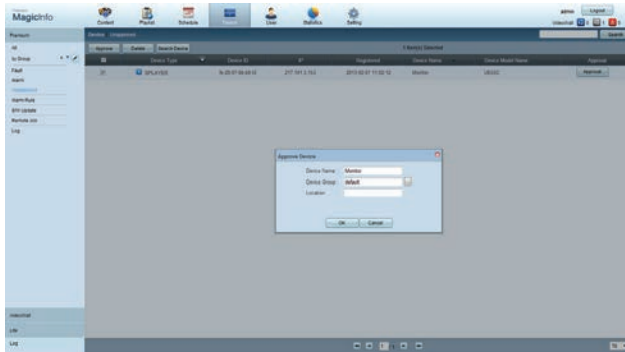

- **Device Name:** Enter the device name.
- **Device Group:** Select to specify the group.
- **Location:** Enter the current location of the device.

— Pressing the INFO button on the remote when a network schedule is running will display the details of the schedule. Check that the correct device has been selected by viewing the device ID in the details.

8 Select the **All** menu to check that the device has been registered.

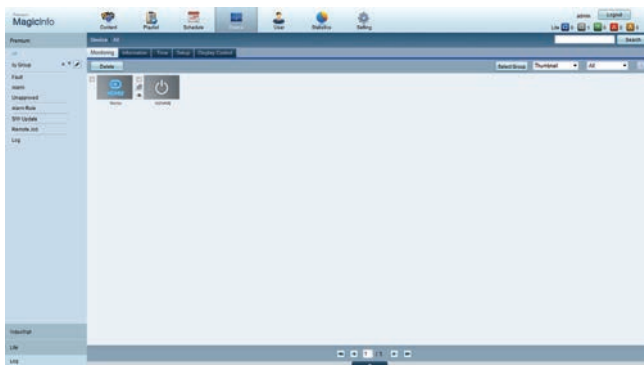

9 When the device is approved by the server, the schedule registered in the selected group will be downloaded to the device. The schedule will run after it is downloaded.

- For further details on how to configure a schedule, refer to the <MagicInfo Premium Server user's manual>.
- If a device is deleted from the list of devices approved by the server, the device will reboot to reset its settings.

Setting the current time

A schedule may not run if the time set on the device is different from the server's current time.

1 Go to the tabs **Device** → **Time**.

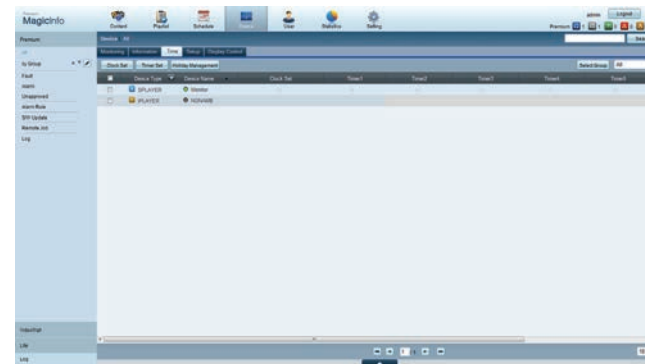

2 Select your device.

3 Select **Clock Set**, and sync the time with the server.

- When connecting to the server for the first time, the time on the product is set using the GMT time of the region where the server is installed.
- The time on the product can be changed from the server as shown in step 3.
- Turning the product off and then on again will restore the time setting on the product to the last time that was set from the server.

— For further details on how to manage the time (scheduling, holiday management, etc.), refer to the <MagicInfo Premium Server user's manual>.

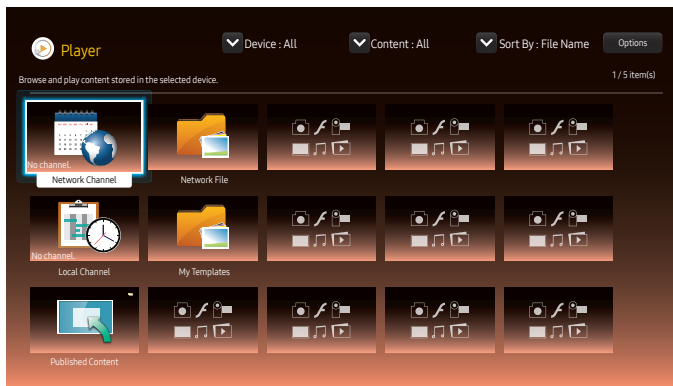

– The displayed image may differ depending on the model.

Network Channel

Play content, templates and schedules configured on the server.

- You can view whether the server is connected (approval) in the **Player** menu screen.
To view whether the server is connected when a **Network Channel** is running, press **INFO** on the remote.

- 1 Select **Network Channel** from the **Player** menu.
 - The **No channel.** message appears if no channel has been registered in **Network Channel**.
- 2 **Network Channel** will run.

Local Channel

Play a schedule or channel that was configured in the product.

- 1 Select **Local Channel** from the **Player** menu.
 - The **No channel.** message appears if no channel has been registered in **Local Channel**.
- 2 **Local Channel** will run.

Published Content

Play a template stored on a connected USB device.

- The **Published Content** feature appears only when a USB device containing templates is connected.
- Play scheduled content.

Network File

Content files included in schedules that have been downloaded through MagicInfo Server are displayed.

My Templates

Play a template in **My Templates** stored in the internal memory of the product.

Available features in the Player page

The **Player** list page provides the following features.

- **Device**
Select either **Internal** or **USB** to search for a desired device list.
 - **All / Internal / USB**
- **Content**
Select a content type as criterion to search for a desired content list.
 - **All / Video / Image / PDF / Flash / Office / My Templates**
- **Sort By**
Specify the content sort criterion.
 - **File name / Recently Played**
- **Options**

Menu items in the Player page

Option Name	Operations
Play Selected	Select and play desired content.
Send	Copy content to another storage device.
Delete	Delete desired content.
Settings	Configure detailed properties of content. — See the following page for details on the Settings feature.

Player page Settings menu

Settings

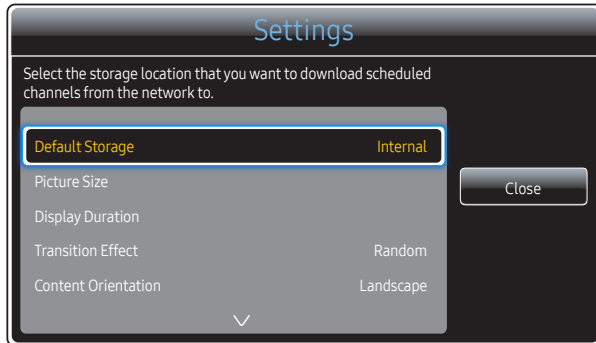

– The displayed image may differ depending on the model.

Default Storage

Select the storage location that you want to download scheduled channels from the network to.

- **Internal / USB**

Picture Size

Set the screen size for content.

If **Picture Size** is set to **Video** or **Image**

- **Full Screen / Original Size / Fit to Screen**

If **Picture Size** is set to **PDF** or **Office**

- **Full Screen / Original Size**

– This feature is only available for **Video**, **Image**, **PDF** and **Office** files.

Display Duration

Set the duration for each page in a slideshow.

– This feature is only available for **Image**, **PDF**, **Flash** and **Office** files.

Transition Effect

Configure transition effects between pages or scenes in a slideshow or video file.

- **None / Fade1 / Fade2 / Blind / Spiral / Checker / Linear / Stairs / Wipe / Random**

– This feature is only available for **Image** files.

Content Orientation

Switch the orientation of playing content to **Landscape** or **Portrait** mode.

- **Landscape / Portrait**

– If **Content Orientation** is **Portrait** view, it does not support VP8 video codec.

– **Source** is not available when **Content Orientation** is set to **Portrait**.

Default Content

This default content will be displayed if you run a channel while no programs are scheduled on the channel.

- [None](#)

Safely Remove

Safely removes USB memory

Reset

Restore all the values under [Settings](#) to the default when the product was purchased.

When Content is Running

Viewing the details of the content that is running

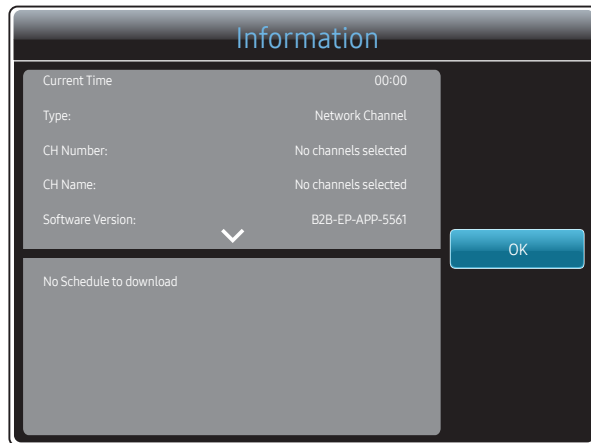

– The displayed image may differ depending on the model.

Press the INFO button on the remote control.

- **Current Time**
- **Type** : Type of channel currently playing
 - Only applicable during **Network Channel** / **Local Channel** playback.
- **CH Number**: Number assigned to the channel currently playing
 - Only applicable during **Network Channel** / **Local Channel** playback.
- **CH Name**: Name of the channel currently playing
 - Only applicable during **Network Channel** / **Local Channel** playback.
- **Software Version**: Displays the software version of a device
- **MAC ID**: Displays the original identification number of a device
- **Tags**: Tag settings assigned to a device from the server
 - Only applicable during **Network Channel** / **Local Channel** playback.
- **Server**: Displays the connection status (**Connected**, **Not connected** or **Non-Approval**) of the server
- **USB**: Displays the connection status of a USB device

Changing the settings for the content that is running

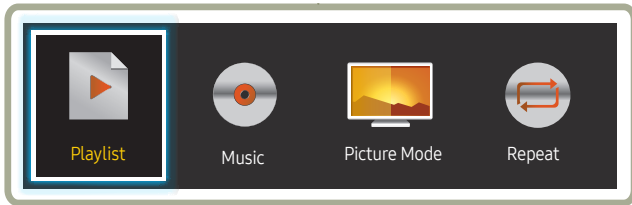

- The displayed image may differ depending on the model.
- This feature is not available when content is playing through Video Wall.

Press the TOOLS button on the remote control during content playback to configure settings such as **Picture Mode**.

- **Playlist**
View a list of content items currently playing.
- **Music**
Set the background music for the content currently playing.
- **Picture Mode**
Customizes the screen settings for the content currently playing
 - **Shop & Mall / Office & School / Terminal & Station / Video Wall / Calibration**
- **Repeat**
Set the repeat mode.
 - **One / All**

File Formats Compatible with Player

- Supported file systems include FAT32 and NTFS.
- A file with a vertical and horizontal resolution larger than the maximum resolution cannot be played.
Check the vertical and horizontal resolution of the file.
- Check the supported video and audio Codec types and Versions.
- Check the supported file versions.
 - Flash player 11.0 and older and Flash Air 3.0 and older versions are supported.
 - PowerPoint version up to 97 – 2007 is supported
- Only the last USB device that was connected is recognized.

Network Schedule Multiframe

Playback restrictions

- A maximum of two video files (**Video**) can be played simultaneously.
- For video files with vertical dimensions of 1080p or larger, only one file can be played at a time.
- The maximum number of 4096 x 4096-dimension image files that can be played simultaneously from a media slide is four.
- More than one **Flash** file cannot be played.
- If an input source element is included, only one video file or media slide can be played simultaneously.
- In a combination of "video files + Flash files + input source elements," supported combinations of different content files that can simultaneously play are as follows:
 - Video + Flash
 - Video + input source element
 - Flash + input source element
- For **Office** files (PPT and Word files) and **PDF** files, only one file type is supported at a time.
- LFD(.lfd) files are not supported.

Sound output restrictions

- More than one sound output cannot be used.
- Playback priority: **Flash** file > network BGM > local BGM > video file in the main frame selected by the user
 - Network BGM: Settings can be configured in step 1 when creating a server schedule.
 - Local BGM: BGM settings can be configured using the tools displayed after the **TOOLS** button is pressed during **Player** playback.
 - User-selected main frame: Main frame settings can be configured in step 2 when creating a server schedule.

Template files and LFD(.lfd) files

Restrictions

- Ensure a distributed folder (content / schedules) exists in **Internal** / **USB** memory.

Playback restrictions

- A maximum of two video (**Video**) files can be played.
- More than one **Flash** file cannot be played.
- For **Office** files (PPT and Word files) and **PDF** files, only one file type is supported at a time.
- Multiple videos (**Video**) cannot be played on a single display of a video wall simultaneously.

Sound output restrictions

- More than one sound output cannot be used.
- Playback priority: **Flash** file > network BGM > local BGM > video file in the main frame selected by the user

Contents

File Extension	Container	Video Codec	Resolution	Frame rate (fps)	Bit rate (Mbps)	Audio Codec
*.avi	AVI	DivX 3.11 / 4.x / 5.x / 6.x	1920 x 1080	6~30	30	AC3
*.mkv	MKV					LPCM
*.asf	ASF					AAC
*.wmv	MP4	MPEG4 SP / ASP				HE-AAC
*.mp4	3GP					WMA
*.mov	VRO	H.264 BP / MP / HP				DD+
*.3gp	VOB					MPEG(MP3)
*.vro	PS					DTS Core
*.mpg	TS	Motion JPEG				G.711(ALaw,μ-Law)
*.mpeg						
*.ts		Window Media Video v9				
*.tp						
*.trp		MPEG2				
*.flv						
*.vob						
*.svi		MPEG1				
*.m2ts						
*.mts		VP6	640 x 480		4	
*.divx						

Video

- 3D video is not supported.
- Content with a resolution larger than the resolution specified in the table above is not supported.
- Video content with a Bit rate or Frame rate larger than the rate specified in the table above can cause choppy video during playback.
- Video content will not play, or not play correctly, if there is an error in the content or the container.
- Some USB/digital camera devices may not be compatible with the player.
- Supports up to H.264, Level 4.1
- H.264 FMO / ASO / RS, VC1 SP / MP / AP L4 and AVCHD are not supported.
- For all Video codecs except MVC, VP8, VP6:
 - Below 1280 x 720: 60 frame max
 - Above 1280 x 720: 30 frame max
- GMC 2 or higher is not supported.
- Supports only BD MVC Spec.
- Only one video file can play at a time if video files on the monitor use incompatible codecs or the resolution is 1080 x 1920.
- When a single video file is playing, Seamless mode is not supported under the following conditions:
 - Incompatible codec (MVC, VP3, MJPEG) ↔ Incompatible codec
 - Incompatible codec ↔ Compatible codec
 - The resolution is different from that of the monitor
 - The frequency is different from that of the monitor

Audio

- Audio content with a Bit rate or Frame rate larger than the rate specified in the table above can cause choppy audio during playback.
- Video content will not play, or not play correctly, if there is an error in the content or the container.
- Some USB/digital camera devices may not be compatible with the player.
- Supports up to WMA 10 Pro 5.1 channel. WMA lossless audio is not supported.
- QCELP, AMR NB/WB are not supported.

Image

- Compatible image file format : JPEG, PNG, BMP
 - 32-bit, 24-bit and 8-bit BMP files are supported.
- Supported maximum resolution : 4096 x 4096
- Supported maximum file size: 20MB
- Supported image effects : 9 effects (Fade1, Fade2, Blind, Spiral, Checker, Linear, Stairs, Wipe, Random)

Flash

- Flash player 11.0 and older and Flash Air 3.0 and older versions are supported.
- Flash Animation
 - Compatible file format : SWF
- Recommended resolution : 1280 x 720
 - Caution
Performance comparable to Flash Player on a Windows operating system cannot be guaranteed
Optimization is needed during content creation
- Flash Video
 - Compatible file format : FLV
 - Video
Codec : H.264 BP
Resolution : 1920 x 1080
 - Audio
Codec : H.264 BP
 - Caution
F4V file format is not supported
Screen Video is not supported

Power Point

- Compatible document file formats
 - Extension : ppt, pptx
 - Version : Office 97 ~ Office 2007
- Functions not supported
 - Animation effect
 - 3D shapes (which will be displayed in 2D)
 - Header and footer (some subitems are not supported)
 - Word Art
 - Align
A group alignment error may occur
 - Office 2007
SmartArt is not fully supported. 97 out of 115 subitems are supported.
 - Object insertion
 - Half-width characters
 - Letter spacing
 - Charts
 - Vertical text
some subitems are not supported
 - Slide notes and handout

PDF

- Compatible document file formats
 - Extension : pdf
- Functions not supported
 - Content less than 1 pixel not supported because of performance degradation issue.
 - Masked Image, Tiled Image content not supported.
 - Content with Rotated Text, not supported.
 - 3D Shadow Effects not supported.
 - Some characters not supported (Special characters may be corrupted)

WORD	Template files	LFD	Streaming
<ul style="list-style-type: none"> • Compatible document file formats <ul style="list-style-type: none"> – Extension : .doc, .docx – Version : Office 97 ~ Office 2007 • Functions not supported <ul style="list-style-type: none"> – Page background effect – Some paragraph styles – Word Art – Align <ul style="list-style-type: none"> A group alignment error may occur – 3D shapes (which will be displayed in 2D) – Office 2007 <ul style="list-style-type: none"> SmartArt is not fully supported. 97 out of 115 subitems are supported. – Charts – Half-width characters – Letter spacing – Vertical text <ul style="list-style-type: none"> some subitems are not supported – Slide notes and handout 	<ul style="list-style-type: none"> • Creation/editing/playback are only available in Template. 	<ul style="list-style-type: none"> • Supported in Network Channel and Local Channel • Compatible document file formats <ul style="list-style-type: none"> – Extension : .lfd 	<ul style="list-style-type: none"> • Supported streaming protocols: mms, RTP, HTTP • Only video content is supported

File Formats Compatible with Videowall

— Refer to the <MagicInfo Server user's manual> for further details.

Video

- 3D video is not supported.
- Content with a resolution larger than the resolution specified in the table above is not supported.
- Video content with a Bit rate or Frame rate larger than the rate specified in the table above can cause choppy video during playback.
- Video content will not play, or not play correctly, if there is an error in the content or the container.
- Some USB/digital camera devices may not be compatible with the player.
- Supports up to H.264, Level 4.1
- H.264 FMO / ASO / RS, VC1 SP / MP / AP L4 and AVCHD are not supported.
- For all Video codecs except MVC, VP8, VP6:
 - Below 1280 x 720: 60 frame max
 - Above 1280 x 720: 30 frame max
- GMC 2 or higher is not supported.
- Supports only BD MVC Spec.
- Some codecs may not be supported in portrait playback mode.

Image

- Compatible image file format : Jpeg, bmp, png
- Supported maximum resolution : 15,360 x 8,640
 - A higher resolution image may take longer to display on the screen.

Restrictions

- Only one video (**Video**) file can be played per client.
 - Different content files can be played on the displays of a video wall.
 - Two video (**Video**) files cannot be played on a single display of a video wall.



Available

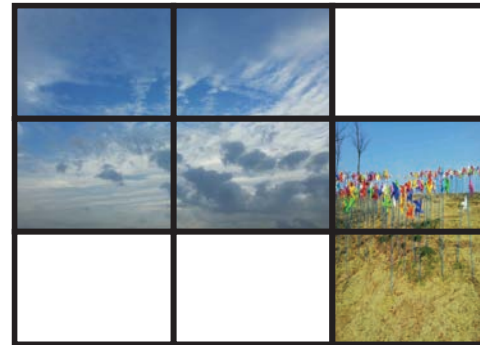

Available



Not available

Schedule

HOME  → Schedule → ENTER 

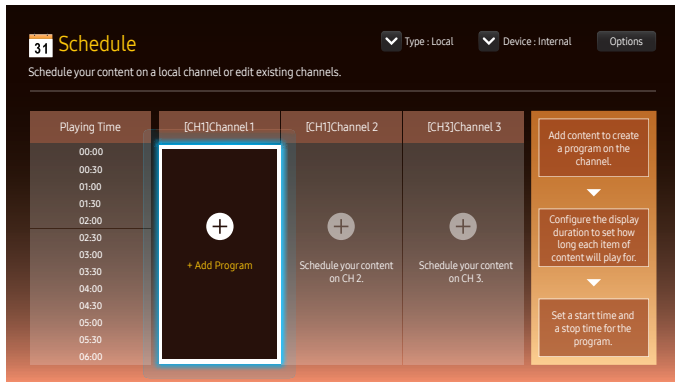

Available features in the Schedule page

The **Schedule** page provides the following features.

- **Type**
 - **Local**: Add or edit schedules.
 - **Network**: View the network schedule configured on the server.
- **Device**
 - Display the name of a connected storage device.
 - This option only activates if **Type** is set to **Local** in **Device**.
- **Options**

Menu items in the Schedule page

Option Name	Operations
Send	Send configured schedules to another storage device. This is similar to the "copy" feature on PCs.
Delete	Delete schedules.

Configuring channel schedules



Play media content such as videos, photos and music at a desired time.

- 1 Select a channel to configure.
- 2 Select video, music and photo content you want to apply to the channel schedule.
- 3 Set the time to play the schedule. (Start Time ~ Stop Time)
- 4 Change the channel schedule name, and then select a destination folder to save to.
- 5 Press the **Save** button.

— Only applicable when **Type** is set to **Local**.

Editing a channel schedule.

Change settings for a configured channel schedule such as content, the duration and the schedule name.

- 1 Select a channel to edit.
- 2 Select video, photo or music content to edit in the channel schedule.
 - Deleting content: Place the cursor over the desired content and then press the  button to delete it.
 - Move to the far right end of the content list. Click the  button to add content or change the playback order of content items.
- 3 Set the time to play the schedule. (Start Time ~ Stop Time)
- 4 Change the channel schedule name, and then select a destination folder to save to.
- 5 Press the **Save** button.

— Only applicable when **Type** is set to **Local**.

Clone Product

HOME  → Clone Product → ENTER 

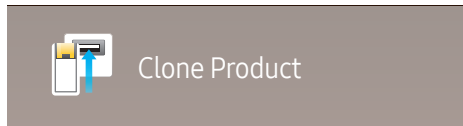

– The displayed image may differ depending on the model.

Export the product settings to a USB device or load the settings via a USB device. This option is useful when assigning the same settings to several products.

When USB does not contain a duplicate file

- 1 Connect the USB device to a USB port. Run the **Clone Product** function.
- 2 The **No cloning file found on the external storage device. Export this device's settings to the external storage device?** message appears.

When USB contains a duplicate file

- 1 Connect the USB device to a USB port. Run the **Clone Product** function.
- 2 The **Settings file found on the external storage device. Please select an option.** message appears.

Run the **Import from External Storage** or **Export to External Storage** function.

- **Import from External Storage:** Copy settings saved on an external storage device to the product.
- **Export to External Storage:** Copy settings on the product to an external storage device.

– After configuration is complete, the product is rebooted automatically.

ID Settings

HOME  → ID Settings → ENTER 

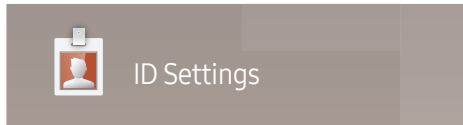

– The displayed image may differ depending on the model.

Assign an ID to a set.

Device ID

Enter the ID number of the product connected to the input cable for input signal reception. (Range: 0~224)

- Press ▲/▼ to select a number, and press .
- Enter the number you want using the number buttons on the remote control.

PC Connection Cable

Select a method to connect to MDC to receive the MDC signal.

- **RS232C cable**
Communicate with MDC via the RS232C-stereo cable.
- **RJ45(LAN) cable**
Communicate with MDC via the RJ45 cable.

Device ID Auto Set

- Assign ID number automatically for all connected products.

Video Wall

HOME  → Video Wall → ENTER 

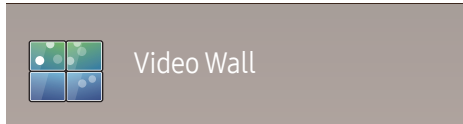

– The displayed image may differ depending on the model.

Customize the layout of multiple displays that are connected to form a video wall.

In addition, display part of a whole picture or repeat the same picture on each of the connected multiple displays.

To display multiple images, refer to MDC Help or the MagicInfo user guide. Some models may not support the MagicInfo function.

Apply to

- **Current Source** (screen output from a device connected to **Source**): Configure videowall features for the screen output from an external device connected to the product.
- **MagicInfo Player S**: Configure videowall features for content saved in the product or content saved on a USB memory or SD card.

Restrictions

– Playback may be initially choppy if video files of different resolutions play successively (i.e., 1280x720 content plays after 1920x1080 content) or an image file and a video file play one after the other.

Video

- Supported resolution
 - 1920 x 1080 @ 24p/30p
 - 1280 x 720 @ 24p/30p/60p
- HEVC and 3D images are not supported.

Image

- Compatible image file format: Jpeg, png, bmp
- Supported maximum resolution
 - jpeg: 15360 x 8640
 - png: 4096 x 4096
 - bmp: 4096 x 4096

Video Wall

You can activate or deactivate **Video Wall**.

To organize a video wall, select **On**.

- **Off / On**

Horizontal x Vertical

This feature automatically splits a videowall display based on a videowall matrix configuration.

Enter the videowall matrix.

The videowall display is split based on the configured matrix. The number of vertical or horizontal display devices can be set within the range 1 and 15.

- A videowall display can be split into a maximum of 225 screens.
- The **Horizontal x Vertical** option is only enabled when **Video Wall** is set to **On**.

Screen Position

To rearrange split screens, adjust the number for each product in the matrix using the **Screen Position** feature.

Selecting **Screen Position** will display the videowall matrix with the numbers assigned to the products that form the videowall.

To rearrange products, use the direction buttons on the remote control to move a product to another desired number. Press the  button.

- **All Displays:** Assign screen positions to All displays. Then, you don't need to set up video wall for individual displays.
- **Current Displays:** Only Assign screen position for this first display.
- **Screen Position** can be set up with a maximum of 15x15 split screens (225 devices). If connected using DP Loopout mode, the maximum number of devices changes to 100.
- The **Screen Position** option is only enabled when **Video Wall** is set to **On**.
- To use the function, make sure **Horizontal x Vertical** is configured.

Format

Select how to display images on the videowall display.

- **Full:** Display images in full screen with no margin.
- **Natural:** Display images in the original aspect ratio without enlarging or reducing the size.
- The **Format** option is only enabled when **Video Wall** is set to **On**.

Network Status

Check the current network and Internet connection.

HOME  → Network Status → ENTER 

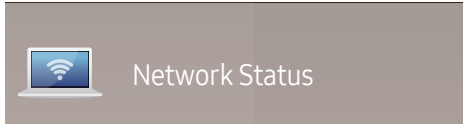

– The displayed image may differ depending on the model.

Picture Mode

HOME  → Picture Mode → ENTER 

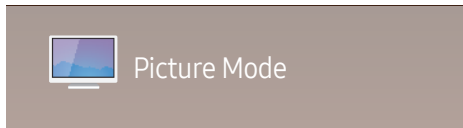

– The displayed image may differ depending on the model.

Select a picture mode (**Picture Mode**) suitable for the environment where the product will be used.

Video/Image mode improves the picture quality of the video device. **Text** mode improves the picture quality of the computer.

- **Shop & Mall**
Suitable for shopping malls.
 - Select either **Video/Image** or **Text** depending on the picture mode.
- **Office & School**
Suitable for offices and schools.
 - Select either **Video/Image** or **Text** depending on the picture mode.
- **Terminal & Station**
Suitable for bus terminals and train stations.
 - Select either **Video/Image** or **Text** depending on the picture mode.
- **Video Wall**
Suitable for environments where videowall display are used.
 - Select either **Video/Image** or **Text** depending on the picture mode.
- **Calibration**
In this mode, the brightness, color, gamma and uniformity settings customized using the color calibration program **Advanced Color Management** are applied.
 - To apply the **Calibration** mode properly, make sure you configure the picture quality settings, such as brightness, color, gamma and uniformity, using the color calibration program **Advanced Color Management**.
 - To download the **Advanced Color Management** program, visit www.samsung.com/displaysolutions.
- **BD Wise**
Provides the optimal picture quality for Samsung DVD, Blu-ray and Home Theater products which support **BD Wise**. When **BD Wise** is turned **On**, the picture mode is automatically changed to the optimal resolution.
 - Available when you connect Samsung products that support **BD Wise** through an HDMI cable to the product.
 - The **BD Wise** function is enabled only when a source device with the **BD Wise** function is connected.

On/Off Timer

HOME  → On/Off Timer → ENTER 

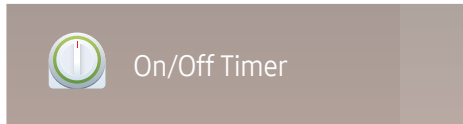

– The displayed image may differ depending on the model.

– You must set **Clock Set** before you can use this feature.

On Timer

Set **On Timer** so that your product turns on automatically at a time and on a day of your choosing.

The power is turned on with the specified volume or input source.

On Timer: Set the on timer by making a selection from one of the seven options. Ensure you set the current time first.

(On Timer1 ~ On Timer7)

- **Setup:** Select **Off, Once, Everyday, Mon~Fri, Mon~Sat, Sat~Sun** or **Manual**.
If you select **Manual**, you can choose the days you want **On Timer** to turn on your product.
 - The check mark indicates days you've selected.
 - **Time:** Set the hour and minute. Use the number buttons or the up and down arrow keys to enter numbers. Use the left and right arrow buttons to change entry fields.
 - **Volume:** Set the desired volume level. Use the left and right arrow buttons to change the volume level.
 - **Source:** Select the input source of your choice.
 - **Content** (when the **Source** is set to **Internal/USB**): From the USB device or internal memory device, select a folder containing content you want to play when the product turns on. Content can include music, photo or video files.
 - This function is available only when a USB device is connected.
- If there is no music file on the USB device or you don't select a folder containing a music file, the Timer function does not operate correctly.
- If there is only one photo file in the USB, the **Slide Show** will not play.
- If a folder name is too long, the folder cannot be selected.
- Each USB you use is assigned its own folder. When using more than one of the same type of USB, make sure the folders assigned to each USB have different names.
- We recommend that you use a USB memory stick and a multi card reader when using **On Timer**.
- The **On Timer** function may not work with USB devices with a built-in battery, MP3 players, or PMPs made by some manufacturers because the product can take too long to recognize these devices.

Off Timer

Set the off timer (**Off Timer**) by making a selection from one of the seven options. (**Off Timer 1 ~ Off Timer 7**)

- **Setup:** Select **Off**, **Once**, **Everyday**, **Mon~Fri**, **Mon~Sat**, **Sat~Sun** or **Manual**.
If you select **Manual**, you can choose the days you want **Off Timer** to turn off your product.
 - The check mark indicates days you've selected.
- **Time:** Set the hour and minute. Use the number buttons or the up and down arrow keys to enter numbers. Use the left and right arrow buttons to change entry fields.

Holiday Management

Timer will be disabled during a period specified as a holiday.

- **Add Holiday:** Specify the period you want to add as a holiday.
Select the start and end dates of the holiday you want to add using the ▲/▼ buttons, and click the **Save** button.
The period will be added to the list of holidays.
 - **Start:** Set the start date of the holiday.
 - **End:** Set the end date of the holiday.
- **Delete:** Delete selected items from the list of holidays.
- **Edit:** Select a holiday item and then change the date.
- **Set Applied Timer:** Set the **On Timer** and **Off Timer** to not activate on public holidays.
 - Press  to select the **On Timer** and **Off Timer** settings you do not want to activate.
 - The selected **On Timer** and **Off Timer** will not activate.

Ticker

HOME  → Ticker → ENTER 

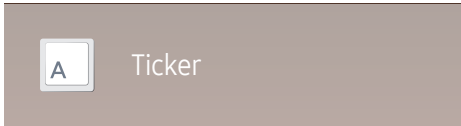

– The displayed image may differ depending on the model.

Input text while a video or image is displayed and display the text on the screen.

- **Off / On**
- **Message:** Enter a message to display on the screen.
- **Time:** Set the **Start Time** and **End Time** to display a **Message**.
- **Font Options:** Specify the text font and color for the message.
- **Position:** Select an orientation to display a **Message**.
- **Scroll:** Specify the scroll **Direction** and **Speed** for the message.
- **Preview:** Preview configured caption settings.

More settings

HOME  → More settings → ENTER 

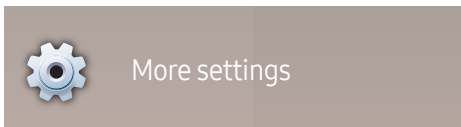

– The displayed image may differ depending on the model.

The picture settings menu appears.

URL Launcher

For details on how to use the **URL Launcher** feature, contact the dealer the product was purchased from.

- To use the **URL Launcher** feature, set **Play via** to **URL Launcher** in **System**.

HOME  → **URL Launcher** → ENTER 

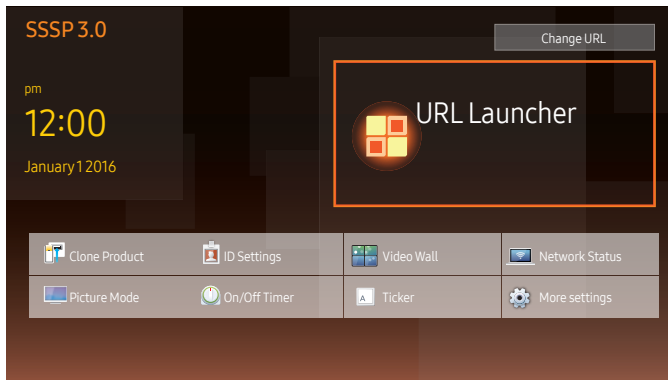

- The displayed image may differ depending on the model.

Chapter 06

Screen Adjustment

Configure the **Picture** settings (**Backlight**, **Color Tone**, etc.).

The layout of the **Picture** menu options may vary depending on the product.

Picture Mode

MENU  → **Picture** → **Picture Mode** → ENTER 

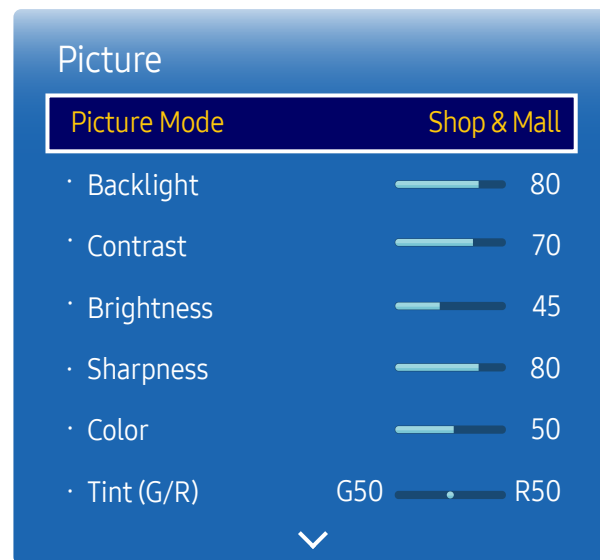

– The displayed image may differ depending on the model.

Select a picture mode (**Picture Mode**) suitable for the environment where the product will be used.

Video/Image mode improves the picture quality of the video device. **Text** mode improves the picture quality of the computer.

- **Shop & Mall**
Suitable for shopping malls.
 - Select either **Video/Image** or **Text** depending on the picture mode.
- **Office & School**
Suitable for offices and schools.
 - Select either **Video/Image** or **Text** depending on the picture mode.
- **Terminal & Station**
Suitable for bus terminals and train stations.
 - Select either **Video/Image** or **Text** depending on the picture mode.
- **Video Wall**
Suitable for environments where videowall display are used.
 - Select either **Video/Image** or **Text** depending on the picture mode.
- **Calibration**
In this mode, the brightness, color, gamma and uniformity settings customized using the color calibration program **Advanced Color Management** are applied.
 - To apply the **Calibration** mode properly, make sure you configure the picture quality settings, such as brightness, color, gamma and uniformity, using the color calibration program **Advanced Color Management**.
 - To download the **Advanced Color Management** program, visit www.samsung.com/displaysolutions.
- **BD Wise**
Provides the optimal picture quality for Samsung DVD, Blu-ray and Home Theater products which support **BD Wise**. When **BD Wise** is turned **On**, the picture mode is automatically changed to the optimal resolution.
 - Available when you connect Samsung products that support **BD Wise** through an HDMI cable to the product.
 - The **BD Wise** function is enabled only when a source device with the **BD Wise** function is connected.

Backlight / Contrast / Brightness / Sharpness / Color / Tint (G/R)

MENU  → Picture → ENTER 

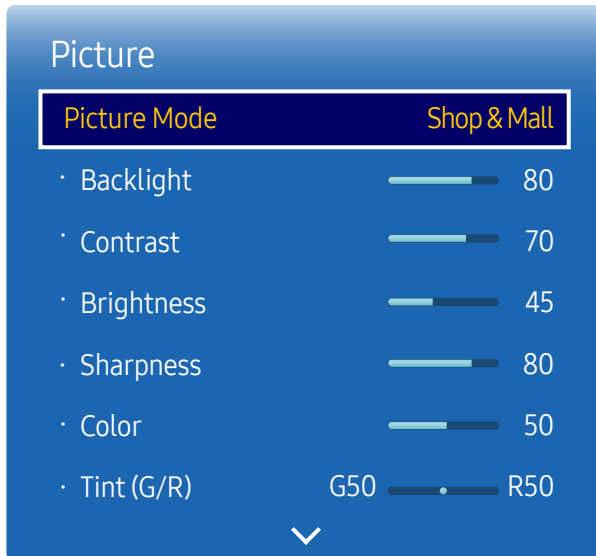

– The displayed image may differ depending on the model.

Your product has several options for adjusting picture quality.

Picture Mode	Picture Mode settings	Adjustable options
Shop & Mall, Office & School, Terminal & Station, Video Wall	Video/Image	Backlight / Contrast / Brightness / Sharpness / Color / Tint (G/R)
	Text	Backlight / Contrast / Brightness / Sharpness
Calibration		Backlight
BD Wise		Backlight / Contrast / Brightness / Sharpness / Color / Tint (G/R)

- When you make changes to **Backlight, Contrast, Brightness, Sharpness, Color** or **Tint (G/R)**, the OSD will be adjusted accordingly.
- You can adjust and store settings for each external device you have connected to an input on the product.
- Lowering picture brightness reduces power consumption.

Color Temperature

MENU  → Picture → Color Temperature → ENTER 

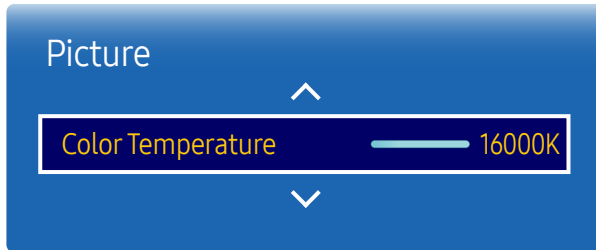

Adjust the color temperature (Red / Green / Blue). (Range: 2800K–16000K)

- Enabled when **Color Tone** is set to **Off**.
- **Color Temperature** is disabled if **Picture Mode** is set to **Calibration** or **BD Wise**.

– The displayed image may differ depending on the model.

White Balance

MENU  → Picture → White Balance → ENTER 

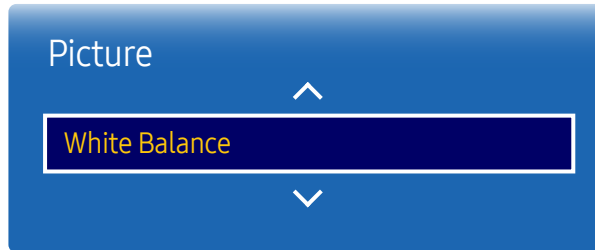

– The displayed image may differ depending on the model.

2 Point

Adjust the color temperature for a more natural picture.

- **R-Offset / G-Offset / B-Offset:** Adjust each color's (red, green, blue) darkness.
- **R-Gain / G-Gain / B-Gain:** Adjust each color's (red, green, blue) brightness.
- **Reset:** Suitable for environments where videowall display are used.

10 Point



Controls the white balance in 10 point interval by adjusting the red, green, and blue brightness.

- **10 Point (Off / On)**
 - **Level, Red, Green, Blue** and **Reset** are enabled only when **10 Point** is set to **On**.
- **Level:** Select interval to adjust.
- **Red:** Adjust the red level.
- **Green:** Adjust the green level.
- **Blue:** Adjust the blue level.
- **Reset:** Suitable for environments where videowall display are used.

– Some external devices may not support this function.

– Enabled when **Picture Mode** is set to **Office & School (Video/Image)**.

Gamma

MENU  → Picture → Gamma → ENTER 

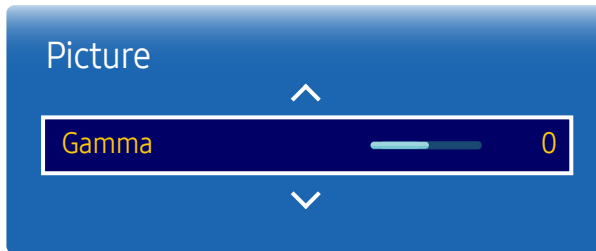

– The displayed image may differ depending on the model.

Calibrated Value

MENU  → Picture → Calibrated Value → ENTER 



– The displayed image may differ depending on the model.

Adjust the primary color intensity.

– If **Picture Mode** is set to **Calibration**, **Gamma** is disabled.

Select whether to apply the brightness, color, gamma and uniformity settings customized using the color calibration program **Advanced Color Management** to the Information and Advertisement modes.

- **Don't Apply / Apply**

– To download the Advanced Color Management program, visit www.samsung.com/displaysolutions.

– If **Picture Mode** is set to **Calibration**, **Calibrated Value** is disabled.

Advanced Settings

MENU  → Picture → Advanced Settings → ENTER 

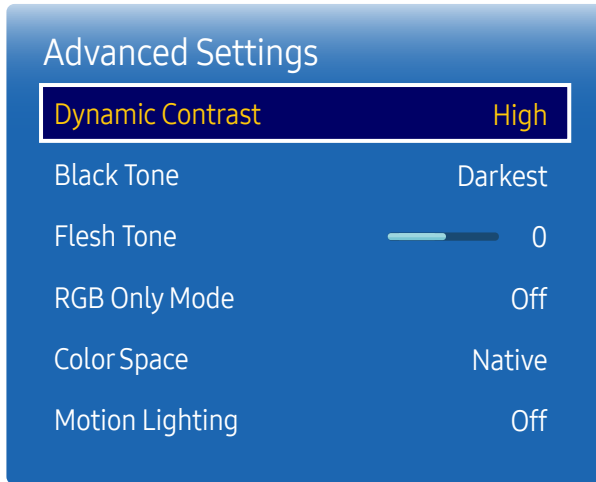

– The displayed image may differ depending on the model.

Picture Mode	Picture Mode settings	Adjustable options
Shop & Mall, Office & School, Video Wall	Video/Image	Dynamic Contrast / Black Tone / Flesh Tone / RGB Only Mode / Color Space
	Text	Dynamic Contrast / Black Tone
Terminal & Station	Video/Image	Dynamic Contrast / Black Tone / Flesh Tone / RGB Only Mode / Color Space / Motion Lighting
	Text	Dynamic Contrast / Black Tone
BD Wise		Dynamic Contrast / Black Tone / Flesh Tone / RGB Only Mode / Color Space

– If **Picture Mode** is set to **Calibration**, **Advanced Settings** is disabled.

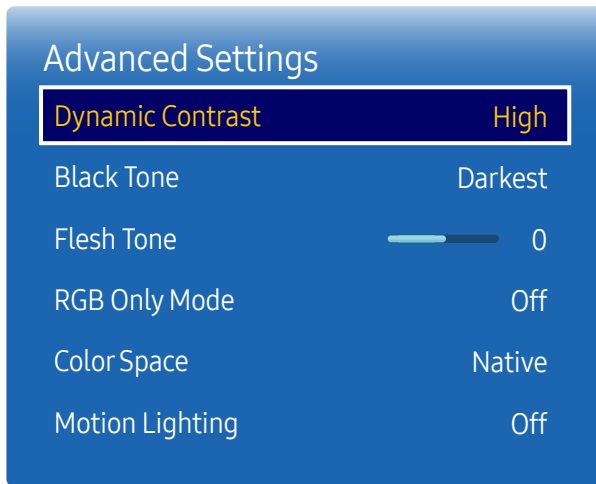

– The displayed image may differ depending on the model.

Dynamic Contrast

Adjust the screen contrast.

- Off / Low / Medium / High

Black Tone

Select the black level to adjust the screen depth.

- Off / Dark / Darker / Darkest

Flesh Tone

Emphasize pink **Flesh Tone**.

RGB Only Mode

Displays the **Red**, **Green** and **Blue** color for making fine adjustments to the hue and saturation.

- Off / Red / Green / Blue

Color Space

Adjusts the range and variety of colors (the color space) available to create images.

- Auto / Native / Custom

– To adjust **Color**, **Red**, **Green**, **Blue** and **Reset**, set **Color Space** to **Custom**.

Motion Lighting

Reduces power consumption by reducing screen brightness when the picture on the screen is in motion.

- Off / On

Picture Options

MENU  → Picture → Picture Options → ENTER 

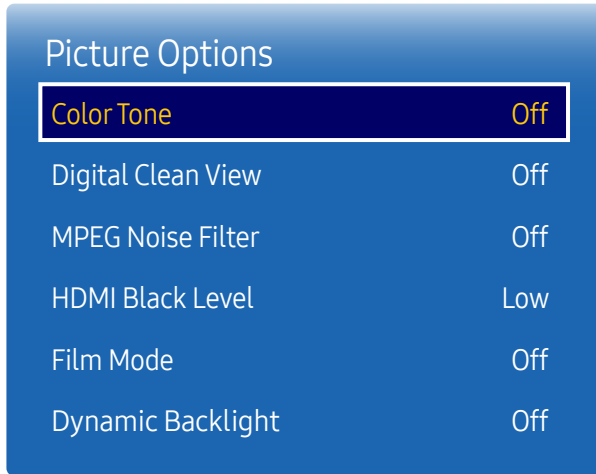

– The displayed image may differ depending on the model.

Picture Mode	Picture Mode settings	Adjustable options
Shop & Mall, Office & School, Terminal & Station, Video Wall	Video/Image	Color Tone / Digital Clean View / MPEG Noise Filter / HDMI Black Level / Film Mode / Dynamic Backlight
	Text	Color Tone / HDMI Black Level / Dynamic Backlight
Calibration		HDMI Black Level / Dynamic Backlight
BD Wise		Color Tone / Digital Clean View / MPEG Noise Filter / HDMI Black Level / Film Mode / Dynamic Backlight

Picture Options

Color Tone	Off
Digital Clean View	Off
MPEG Noise Filter	Off
HDMI Black Level	Low
Film Mode	Off
Dynamic Backlight	Off

– The displayed image may differ depending on the model.

Color Tone

If **Picture Mode** is set to **Text**

- Off / Cool / Standard / Warm

If **Picture Mode** is set to **Video/Image** or **BD Wise**

- Off / Cool / Standard / Warm1 / Warm2

– If **Picture Mode** is set to **Calibration**, **Color Tone** is disabled.

– Settings can be adjusted and stored for each external device connected to an input on the product.

Digital Clean View

If the broadcast signal received by your product is weak, you can activate the **Digital Clean View** feature to reduce any static and ghosting that may appear on the screen.

- Off / Low / Medium / High / Auto

– Received signal intensity is the strongest when the bar is green.

– When the signal is weak, try all the options until the the product displays the best picture.

MPEG Noise Filter

Reduces MPEG noise to provide improved picture quality.

- Off / Low / Medium / High / Auto

Picture Options

Color Tone	Off
Digital Clean View	Off
MPEG Noise Filter	Off
HDMI Black Level	Low
Film Mode	Off
Dynamic Backlight	Off

– The displayed image may differ depending on the model.

HDMI Black Level

Selects the black level on the screen to adjust the screen depth.

- **Auto / Low / Normal**

– Available only in **HDMI**, **DVI** and **DisplayPort** mode (AV Timing : 480p, 576p, 720p, 1080i, 1080p).

Film Mode

This mode is suitable to view movies.

Sets the product to automatically sense and process film signals from all sources and adjust the picture for optimum quality.

- **Off / Auto1 / Auto2**

– Available in **HDMI** (1080i).

Dynamic Backlight

Automatically adjust the backlight to provide the best possible screen contrast under the current conditions.

- **Off / On**

Picture Size

MENU  → Picture → Picture Size → ENTER 



– The displayed image may differ depending on the model.

choose size and aspect ratio picture displayed on screen.

Picture Size

– Different screen adjustment options are displayed depending on the current input source.

- **16:9**: Sets the picture to **16:9** wide mode.
- **Zoom1**: Use for moderate magnification. Cuts off the top and sides.
- **Zoom2**: Use for a stronger magnification.
- **4:3**: Sets the picture to basic (**4:3**) mode.

– Do not set your product to **4:3** format for a long time.

The borders displayed on the left and right, or top and bottom of the screen may cause image retention (screen burn) which is not covered by the warranty.

- **Screen Fit**: Displays the full image without any cut-off when **HDMI** (720p / 1080i / 1080p) signals are inputted.
- **Custom**: Changes the resolution to suit the user's preferences.
- **Original Ratio**: If the input source is **PC**, **DVI**, **HDMI** (PC connection), **DisplayPort**, the video will display in the original aspect ratio.



Position



– The displayed image may differ depending on the model.

Adjusts the picture position. **Position** is only available if **Picture Size** is set to **Zoom1**, **Zoom2**, **Screen Fit** or **Custom**.

– To use the **Position** function after selecting **Zoom1**, **Zoom2**, **Screen Fit** or **Custom**, follow these steps.

- 1 Press the ▼ button to select **Position**. Press the  button.
- 2 Press the ▲ or ▼ button to move the picture up or down.
- 3 Press the  button.



Zoom/Position



– The displayed image may differ depending on the model.

Adjusts the picture zoom and position. This option is available when the input source is set to **HDMI** (1080i/1080p), **DVI** or **DisplayPort**. **Picture Size** must be set to **Custom** for the option to be available.

– **Custom** under **Picture Size** is only enabled when **Picture Mode** is set to **Video/Image** while in **DVI** or **DisplayPort** mode.

- 1 Press the ▼ button to select **Zoom/Position**. Press the  button.
- 2 Select the **Zoom** or **Position**. Press the  button.
- 3 Press the ▲/▼/◀/▶ button to move the picture.
- 4 Press the  button.

– If you want to reset the picture to its original position, select **Reset** in the **Zoom/Position** screen. The picture will be set to its default position.

Resolution

If the picture is not normal even when the resolution of the graphics card is one of the following, you can optimize the picture quality by selecting the same resolution for the product as the PC using this menu.

Available resolutions: **Off** / 1024x768 / 1280x768 / 1360x768 / 1366x768

Auto Adjustment

Adjust frequency values/positions and fine tune the settings automatically.

MENU  → Picture → Auto Adjustment → ENTER 



- Available in **PC** mode only.
- The displayed image may differ depending on the model.

PC Screen Adjustment

MENU  → Picture → PC Screen Adjustment → ENTER 

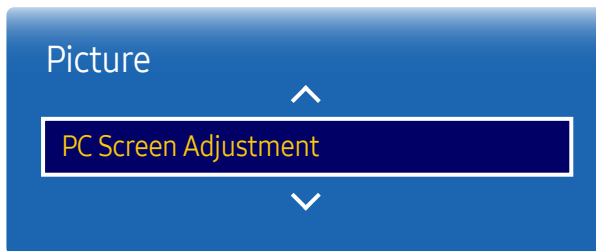

- Available in **PC** mode only.
- The displayed image may differ depending on the model.

- **Coarse / Fine**
Removes or reduces picture noise.
If the noise is not removed by Fine-tuning alone, use the **Coarse** function to adjust the frequency as best as possible (**Coarse**) and Fine-tune again. After the noise has been reduced, re-adjust the picture so that it is aligned with the center of screen.
- **Position**
To adjust the PC's screen position if it is not centered or does not fit the product screen.
Press the ▲ or ▼ button to adjust the Vertical Position. Press the ◀ or ▶ button to adjust the Horizontal Position.
- **Image Reset**
Resets the image to the default settings.

Picture Off

Selecting **Picture Off** switches off the screen. The volume is not disabled.

MENU  → **Picture** → **Picture Off** → ENTER 

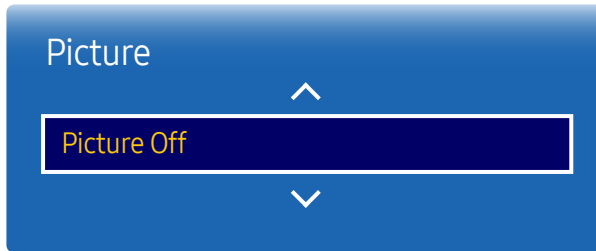

– The displayed image may differ depending on the model.

Reset Picture

Resets your current picture mode to its default settings.

MENU  → **Picture** → **Reset Picture** → ENTER 

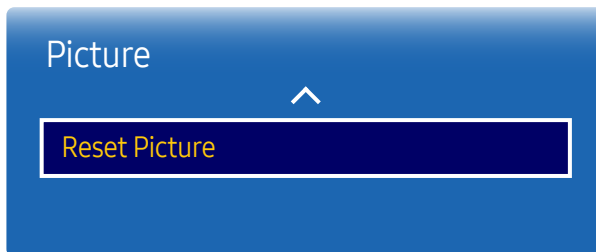



– The displayed image may differ depending on the model.

Chapter 07

OnScreen Display

Display Orientation

MENU  → OnScreen Display → Display Orientation → ENTER 

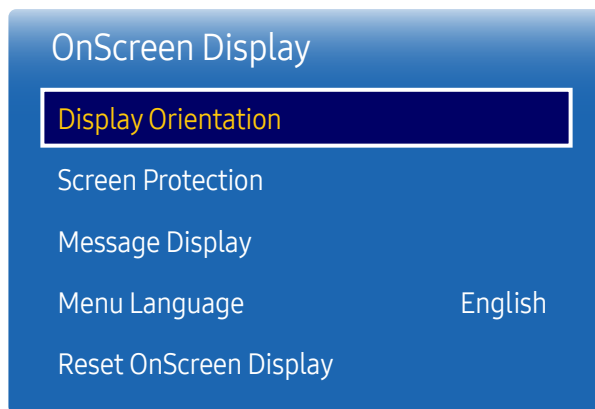

– The displayed image may differ depending on the model.

Source Content Orientation

Set the orientation of content from external devices connected to the product.

- **Landscape:** Display the screen in landscape mode (default).
- **Portrait:** Display the screen in portrait mode.



Aspect Ratio

Set the rotated screen to be either full screen or original.

- **Full Screen:** Display the rotated screen in full screen.
- **Original:** Display the rotated screen in the original aspect ratio.

– Available only when **Source Content Orientation** is set to **Portrait**.

Screen Protection

MENU  → OnScreen Display → Screen Protection → ENTER 



– The displayed image may differ depending on the model.

Auto Protection Time

If the screen displays a still image for a certain period of time you define, the product activates the screen saver to prevent the formation of burnt in ghost images on the screen.

- Off / 2 hours / 4 hours / 8 hours / 10 hours

Screen Burn Protection

To reduce the possibility of screen burn, this unit is equipped with **Screen Burn Protection** screen burn prevention technology.

Screen Burn Protection moves the picture slightly on the screen.

The **Screen Burn Protection Time** setting allows you to program the time between movements of the picture in minutes.

Pixel Shift

Minimize image retention by finely moving pixels horizontally or vertically.

- **Pixel Shift** (Off / On)
 - **Horizontal**, **Vertical** and **Time** are enabled only when **Pixel Shift** is set to **On**.
- **Horizontal**: Sets how many pixels the screen moves horizontally.
- **Vertical**: Sets how many pixels the screen moves vertically.
- **Time**: Set the time interval for performing the horizontal or vertical movement, respectively.

Available Pixel Shift Settings and Optimum Settings.

	Available Settings	Optimum Settings
Horizontal (pixels)	0 ~ 4	4
Vertical (pixels)	0 ~ 4	4
Time (minute)	1 min. ~ 4 min.	4 min.

- The **Pixel Shift** value may differ depending on the product size (inches) and mode.
- Displaying a still image or a **4:3** output for an extended period of time may cause image retention. This is not a defect in the product.
- If **Picture Size** is set to **Screen Fit**, **Pixel Shift** is disabled.

Screen Burn Protection

Pixel Shift

Timer

Immediate Display Off

Side Gray Off

– The displayed image may differ depending on the model.

Timer

You can set the timer for **Screen Burn Protection**.

The **Screen Burn Protection** feature stops automatically after a specified period of time.

Timer

Off

Repeat: Display the image retention-preventive pattern set in **Mode** at specified time intervals(Period).

Interval: Display the image retention-preventive pattern set in **Mode** for a specified period of time (from **Start Time** to **End Time**).

– **Mode, Period, Time, Start Time** and **End Time** are enabled only when **Timer** is set to **Repeat** or **Interval**.

- **Mode:** Select a screen protective pattern to display.
 - **Pixel:** Pixels on the screen alternate black continuously.
 - **Rolling Bar:** A vertical bar moves left to right.
 - **Fading Screen:** The entire screen becomes brighter, then darker.

– The **Rolling Bar** and **Fading Screen** patterns appear only once regardless of the specified repeat period or time.

- **Period:** Specify the time interval to activate the **Screen Burn Protection** function.

– The option is enabled when **Repeat** is selected for **Timer**.

- **Time:** Specify the duration to keep the **Screen Burn Protection** function on.

– Enabled when **Timer** is set to **Repeat** and **Mode** is set to **Pixel**.

- **Start Time:** Set the start time to activate the screen protection function.

– The option is enabled when **Interval** is selected for **Timer**.

- **End Time:** Set the end time to deactivate the screen protection function.

– The option is enabled when **Interval** is selected for **Timer**.

Screen Burn Protection

Pixel Shift

Timer

Immediate Display Off

Side Gray Off

Immediate Display

Select the screen saver you want to display immediately.

- Off / Pixel / Rolling Bar / Fading Screen



Side Gray

When the screen is set to 4:3 aspect ratio, adjust the brightness of white margins on sides to protect the screen.

- Off / Light / Dark

– The displayed image may differ depending on the model.

Message Display

MENU  → OnScreen Display → Message Display → ENTER 

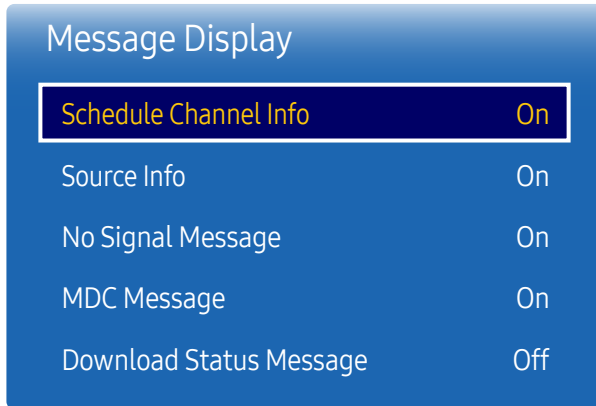

– The displayed image may differ depending on the model.

Schedule Channel Info

Select whether to display channel information in the schedule.

- Off / On

Source Info

Select whether to display the source OSD when the input source changes.

- Off / On

No Signal Message

Select whether to display the no-signal OSD when no signal is detected.

- Off / On

MDC Message

Select whether to display the MDC OSD when the product is controlled by the MDC.



- Off / On

Download Status Message

Select to display the status when downloading content from a server or other device.

- Off / On

Menu Language

MENU  → OnScreen Display → Menu Language → ENTER 

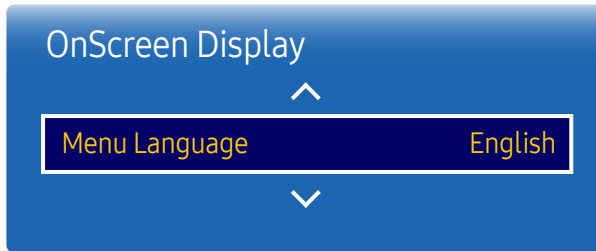

– The displayed image may differ depending on the model.

Set the menu language.

- A change to the language setting will only be applied to the onscreen menu display. It will not be applied to other functions on your PC.

Reset OnScreen Display

MENU  → OnScreen Display → Reset OnScreen Display → ENTER 

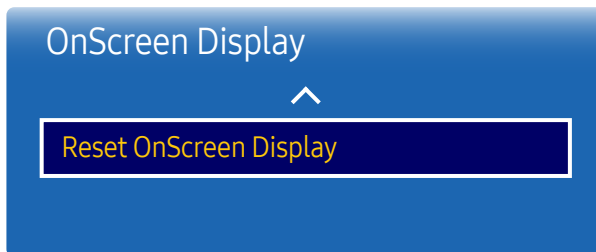

– The displayed image may differ depending on the model.

This option returns the current settings under **OnScreen Display** to the default factory settings.

Chapter 08

Sound Adjustment

Configure the sound (Sound) settings for the product.

HDMI Sound

MENU  → Sound → HDMI Sound → ENTER 



Select whether to hear from AV(HDMI) or PC(DVI).

- AV(HDMI) / PC(DVI)

– The displayed image may differ depending on the model.

Speaker Settings

MENU  → Sound → Speaker Settings → ENTER 

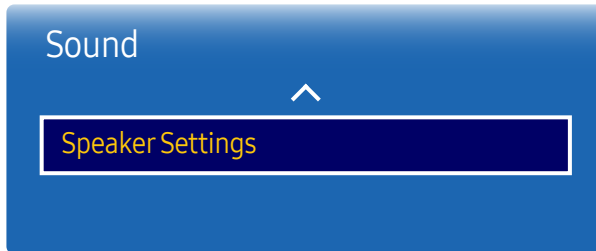

– The displayed image may differ depending on the model.

Sound Output

- External / Receiver

– If there is no video signal, both the products speakers and the external speakers will be mute.

Chapter 09

Network

Network Status

MENU  → Network → Network Status → ENTER 

You can check the current network and Internet status.

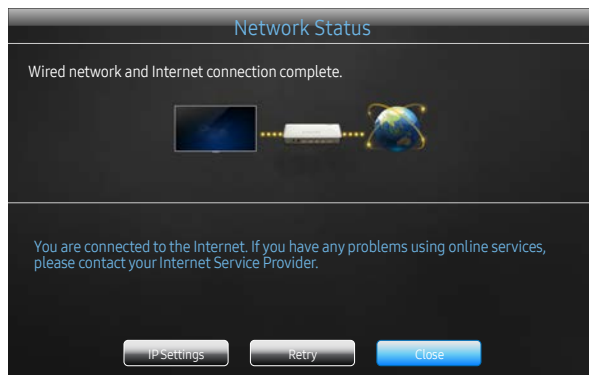

– The displayed image may differ depending on the model.

Network Settings

MENU  → Network → Network Settings → ENTER 

Configure network settings to use various smart hub features such as Internet search, content sharing through a home network and feature updates.

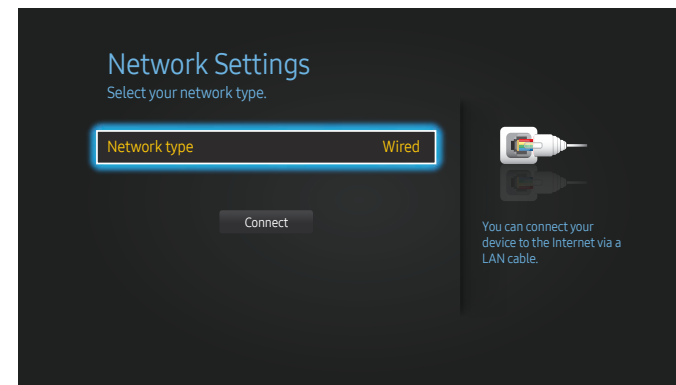

– The displayed image may differ depending on the model.

Network type

- Wired

Network Settings (Wired)

Connecting to a Wired Network

There are three ways to attach your product to your LAN using cable.

- You can attach your product to your LAN by connecting the LAN port on the back of your product to an external modem using a LAN cable. See the diagram below.

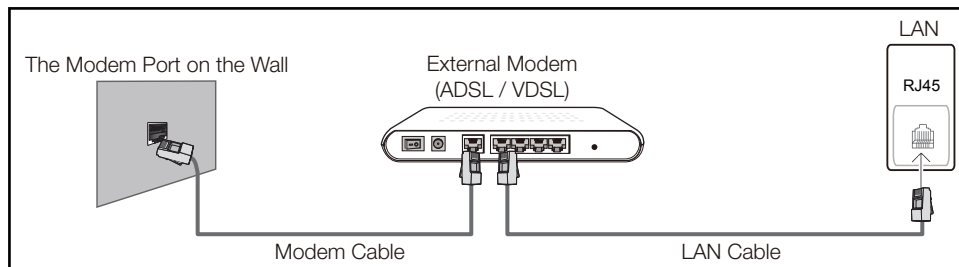

- You can attach your product to your LAN by connecting the LAN port on the back of your product to an IP Sharer which is connected to an external modem. Use LAN cable for the connection. See the diagram below.

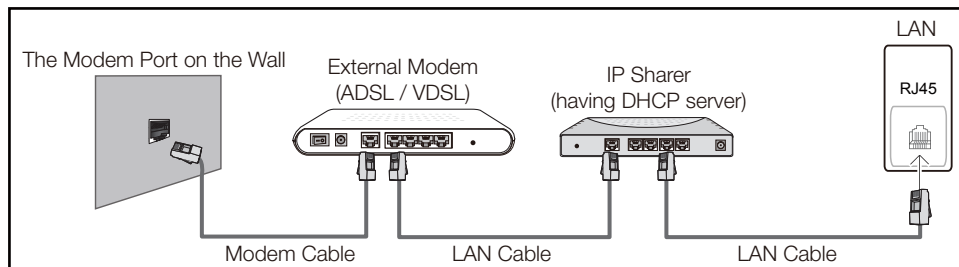

- Depending on how your network is configured, you may be able to attach your product to your LAN by connecting the LAN port on the back of your product directly to a network wall outlet using a LAN cable. See the diagram below. Note that the wall outlet is attached to a modem or router elsewhere in your house.

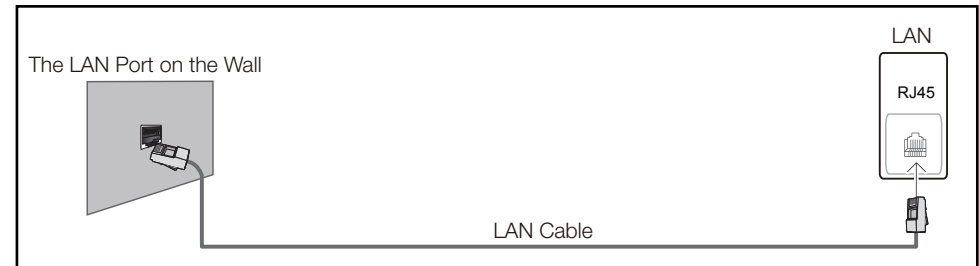

If you have a Dynamic Network, you should use an ADSL modem or router that supports the Dynamic Host Configuration Protocol (DHCP). Modems and routers that support DHCP automatically provide the IP address, subnet mask, gateway, and DNS values your product needs to access the Internet so you do not have to enter them manually. Most home networks are Dynamic Networks.

Some networks require a Static IP address. If your network requires a Static IP address, you must enter the IP address, subnet mask, gateway, and DNS values manually on your product Cable Setup Screen when you set up the network connection. To get the IP address, subnet mask, gateway, and DNS values, contact your Internet Service Provider (ISP).

If you have a Windows computer, you can also get these values through your computer.

- You can use ADSL modems that support DHCP if your network requires a Static IP address.
- ADSL modems that support DHCP also let you use Static IP addresses.

Set the network connection to use Internet services such as perform software upgrades.

Automatic Network Settings (Wired)

Connect to the network using a LAN cable.
Make sure a LAN cable is connected first.

How to set up automatically

- 1 Set **Network type** to **Wired** from the **Network Settings** page.
- 2 Press the **Connect** button to start **Network Settings**.
 - The **Connect** button is only enabled when the LAN cable is properly connected.
- 3 The network test screen appears and verifies the network connection.

When the connection has been verified, the “**Wired network and Internet connection completed.**” message appears.
 - If the connection process fails, check the LAN port connection.
 - If the automatic process cannot find the network connection values or if you want to set the connection manually, go to the next section, network setup.

Manual Network Settings (Wired)

Offices may use static IP addresses.
If this is the case, ask the network administrator for the IP address, subnet mask, gateway and DNS server address. Enter these values manually.



Getting the Network Connection Values

To view the Network connection values on most Windows computers, follow these steps.

- 1 Right click the Network icon on the bottom right of the screen.

- 2 In the pop-up menu that appears, click **Status**.
- 3 On the dialog that appears, click the **Support** tab.
- 4 On the **Support** Tab, click the **Details** button. The Network connection values are displayed.

How to set up manually

- 1 Set **Network type** to **Wired** from the **Network Settings** page.
- 2 Press the **Connect** button to start **Network Settings**.
 - The **Connect** button is only enabled when the LAN cable is properly connected.
- 3 The network test screen appears and the verification process starts. Press **Stop**. The verification process stops.
- 4 Select **IP Settings** on network connection screen. The **IP Settings** screen appears.
- 5 Select the field at the top, press , and then set **IP Settings** to **Enter manually**. Repeat the entry process for each field in the **IP Address**.
 - Setting **IP Settings** to **Enter manually** automatically changes **DNS Setting** to **Enter manually**.
- 6 When done, select **OK** at the bottom of the page, and then press . The network test screen appears and the verification process starts.
- 7 When the connection has been verified, the “**Wired network and Internet connection completed.**” message appears.

Multimedia Device Settings

MENU  → Network → Multimedia Device Settings → ENTER 

Allow other devices such as smart phones and tablets on your network, to share content with your product.

Server Network Settings

MENU  → Network → Server Network Settings → ENTER 

Connect to Server

To run **Player** connect to a network.

- **Server Address / SSL / Port**

— If the **SSL** option is enabled, the server is configured to use **https** and data transfer is encrypted.

— Enter the server IP address and port number. Use 7001 as the port number. (If unable to connect to the server using port number 7001, check with your server administrator to find the correct port number and then change the port number.)

MagicInfo Mode

Select the appropriate **MagicInfo Mode** depending on the environment where you are using the product.

- **Lite / Premium**

Server Access

Select a method to connect the server network.

- **Allow / Deny**

FTP Mode

Specify the FTP operating mode.

- **Active / Passive**

Device Name

MENU  → Network → Device Name → ENTER 

Select or enter a device name.

This name can be shown on network remote controls over the network.

- **User Input / [Signage]Display 1 ~ 6**

Chapter 10

System

Accessibility

MENU  → System → Accessibility → ENTER 

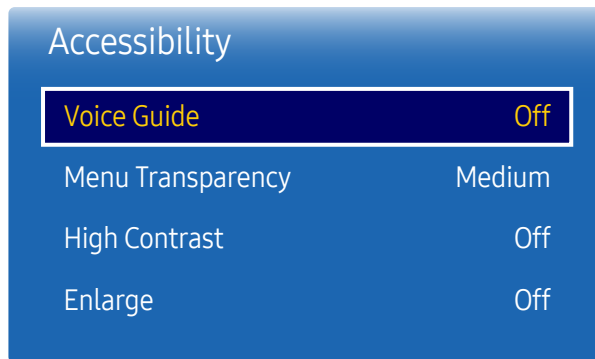

– The displayed image may differ depending on the model.

Voice Guide

Voice Guide

Switch **Voice Guide** on or off. The language used for **Voice Guide** will be the same as the current menu language.

- Off / On
- Volume, Speed and Pitch are enabled only when **Voice Guide** is set to On.

Volume

Set the volume level for the **Voice Guide**.

- Loud / Medium / Soft

Speed

Set the speed of the **Voice Guide**.

- Fast / Normal / Slow

Pitch

Tune the pitch of the **Voice Guide**.

- High / Medium / Low

Accessibility

Voice Guide Off

Menu Transparency Medium

High Contrast Off

Enlarge Off

Menu Transparency

Adjust transparency of menu box.

- High / Medium / Low

High Contrast

Set the background and font to high-contrast colors in Menu. Menu transparencies become opaque when the option is selected.

- Off / On



Enlarge

Set whether to enlarge highlighted item in Menu.

- Off / On

– The displayed image may differ depending on the model.

Setup

MENU  → System → Setup → ENTER 

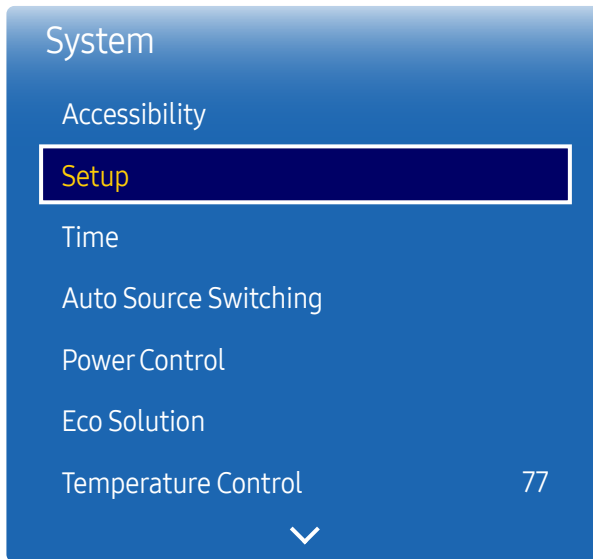



– The displayed image may differ depending on the model.

Initial settings (System)

Go through the initial setup steps like you did the first time you used this product.

- Enter your 4 digit PIN number. The default PIN number is “0-0-0-0”.
If you want to change the PIN number, use the **Change PIN** function.

Time

MENU  → System → Time → ENTER 

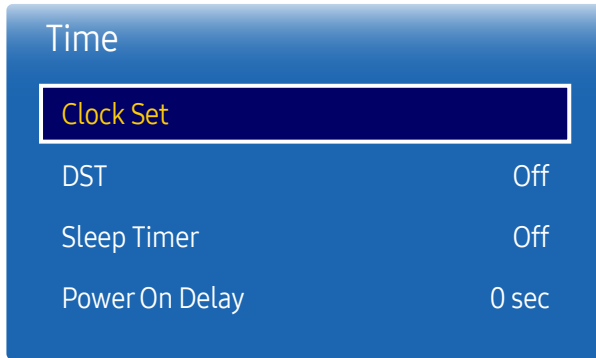

– The displayed image may differ depending on the model.

You can configure **Clock Set** or **Sleep Timer**. You can also set the product to automatically turn on or off at a specified time using the **Timer** function.

– Press the INFO button if you want to view the current time.

Clock Set

Select **Clock Set**. Select **Date** or **Time**, and then press .

Use the number buttons to enter numbers or press the up and down arrow buttons. Use the left and right arrow buttons to move from one entry field to the next. Press  when done.

– You can set the **Date** and **Time** directly by pressing the number buttons on the remote control.

DST

Switches the DST (Daylight Saving Time) function on or off.

Off / On

- **Start Date:** Set the start date of Daylight Saving Time.
- **End Date:** Set the end date of Daylight Saving Time.
- **Time Offset:** Select the correct time offset your timezone.

Sleep Timer

Automatically shuts off the product after a preset period of time.

(Off / 30 min. / 60 min. / 90 min. / 120 min. / 150 min. / 180 min.)

– Use the up and down arrows to select a period of time, and then press . To cancel **Sleep Timer**, select **Off**.

Power On Delay

When connecting multiple products, adjust the power-on time for each product to prevent power overload (within the range 0–50 seconds).

Auto Source Switching

MENU  → System → Auto Source Switching → ENTER 

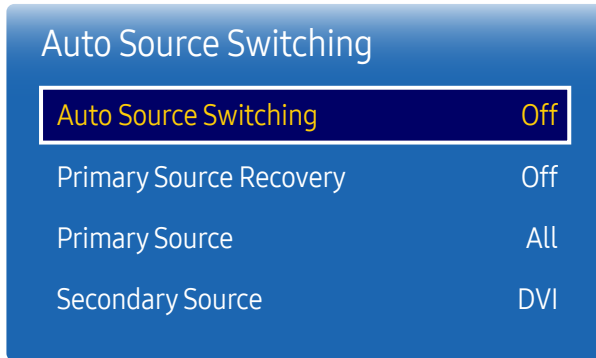

– The displayed image may differ depending on the model.

Turning on the display with **Auto Source Switching On**, and the previous video source selection is not active, the display will automatically search the different video input sources for active video.

Auto Source Switching

When the **Auto Source Switching** is **On**, the display video source will automatically be searched for active video. The **Primary Source** selection will be activated, if the current video source is not recognized.

Secondary Source selection will become active, if no primary video source is available.

If both the primary and secondary input sources are not recognized, the display will perform two searches for an active source, each search checking the primary and then secondary source. If both searches fail, the display will return to the first video source and display a message indicating that there is no signal.

When the **Primary Source** selection is set to **All**, the display will search all the video source inputs twice in sequence looking for an active video source, returning back to the first video source in the sequence if no video is found.

Primary Source Recovery

Select whether to restore the selected primary input source when a primary input source is connected.

– The **Primary Source Recovery** function is disabled if **Primary Source** is set to **All**.

Primary Source

Specify **Primary Source** for the automatic input source.

Secondary Source

Specify **Secondary Source** for the automatic input source.

– The **Secondary Source** function is disabled if **Primary Source** is set to **All**.

Power Control

MENU  → System → Power Control → ENTER 

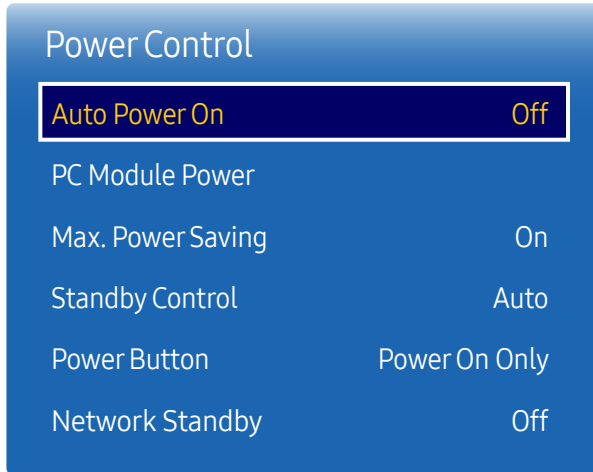

– The displayed image may differ depending on the model.

Auto Power On

This feature automatically turns on the product as soon as it is plugged in. Pressing the power button is not needed.

- Off / On

PC Module Power

The PC module can be turned on/off separately from the LFD.

Synced Power-On

To turn on the PC module without turning on the LFD, select **Off**.

- Off / On

Synced Power-Off

To turn off the LFD without turning off the PC module, select **Off**.

- Off / On

Max. Power Saving

Turns off the product to reduce power consumption after the PC has been left idle for a specified period of time.

- Off / On

– Available only **PC, DVI, HDMI, DisplayPort** mode.

Power Control	
Auto Power On	Off
PC Module Power	
Max. Power Saving	On
Standby Control	Auto
Power Button	Power On Only
Network Standby	Off

– The displayed image may differ depending on the model.

Standby Control

You can set the screen standby mode to be applied when an input signal is received.

- **Auto**
Power-saving mode will activate if no input signals are detected even though a source device is connected to the display.
The message **No Signal** will appear if no source device is connected.
- **Off**
The message **No Signal** will appear if no input signals are detected.
 - The **Standby Control** option is only enabled when **Source** is set to **PC, DVI, HDMI** or **DisplayPort**.
 - If **No Signal** is displayed although a source device is connected, check the cable connection.
 - If **No Signal Message** is set to **Off**, the **No Signal** message does not appear.
If this is the case, set **No Signal Message** to **On**.
- **On**
Power-saving mode will activate if no input signals are detected.

Power Button

The power button can be set to either turn on the power or turn on/off the power.

- **Power On Only**: Set the power button to turn on the power.
- **Power On/Off**: Set the power button to turn on/off the power.

Network Standby

This feature keeps the network power on when the product turns off.

- **Off / On**

Eco Solution

MENU  → System → Eco Solution → ENTER 

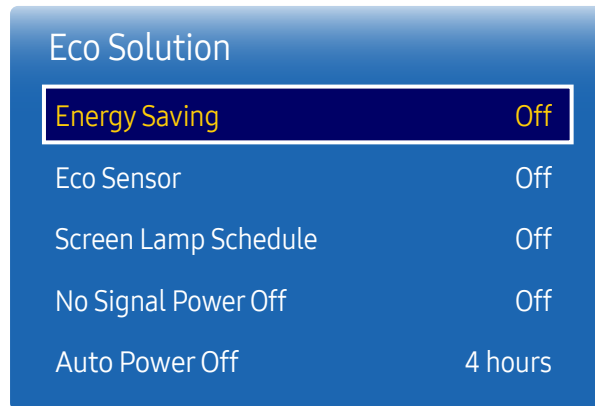

– The displayed image may differ depending on the model.

Energy Saving

Reduce the power consumption by adjusting the screen brightness.

- Off / Low / Medium / High

Eco Sensor

To enhance your power savings, the picture settings will automatically adapt to the light in the room.

- Off / On

– Adjusting the **Backlight** setting under **Picture** while **Eco Sensor** is on will disable the **Off**.

– If the screen contrast is not sufficient, set the **Eco Sensor** to **Off**.
If the **Eco Sensor** is **Off**, it may not comply with energy standards.

Min. Backlight

When **Eco Sensor** is **On**, you can manually adjust the minimum screen brightness. **Min. Backlight** is the darkest backlight mode. Make sure the **Min. Backlight** setting is lower than the **Backlight** setting.

– If **Eco Sensor** is **On**, the display brightness may change (become slightly darker or brighter) depending on the surrounding light intensity.

Eco Solution

Energy Saving	Off
Eco Sensor	Off
Screen Lamp Schedule	Off
No Signal Power Off	Off
Auto Power Off	4 hours

– The displayed image may differ depending on the model.

Screen Lamp Schedule

Screen Lamp Schedule

Enable or disable the lamp schedule.

- Off / On

Schedule1, Schedule2

Time

The panel brightness will change to the brightness set in **Lamp** at a specified time.

Lamp

Adjust the panel brightness. A value closer to 100 makes the panel brighter.

- 0 ~ 100

No Signal Power Off

Save power by turning the device off when no signal is received from any source.

- Off / 15 min. / 30 min. / 60 min.

– Disabled when an attached PC is in power saving mode.

– The product will automatically power off at a specified time. The time can be changed as required.

Auto Power Off

The product will automatically turn off if you don't press a button on the remote or touch a button on product front panel within select hours to prevent overheating.

- Off / 4 hours / 6 hours / 8 hours

Temperature Control

MENU  → System → Temperature Control → ENTER 



– The displayed image may differ depending on the model.

This function detects the internal temperature of the product. You can specify the temperature range that is acceptable.

The default temperature is set to 77°C.

The recommended operating temperature for this product is 75 to 80°C (based on an ambient temperature of 40°C).

- The screen will become darker if the current temperature exceeds the specified temperature limit. If the temperature continues to rise, the product will power off to prevent overheating.

Device Manager

MENU  → System → Device Manager → ENTER 

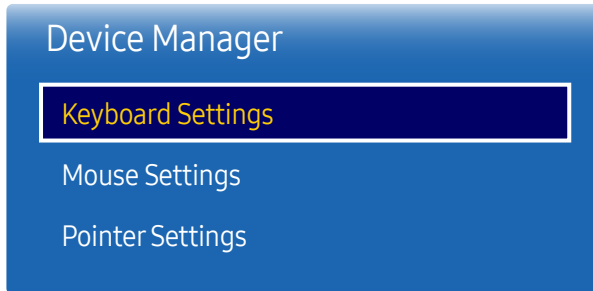

– The displayed image may differ depending on the model.

Configure options for external input devices connected to the product.

Keyboard Settings

Connecting a keyboard to the product displays the **Keyboard Settings** menu.

Select Keyboard

Select a keyboard you want to use from the available connected keyboards.

– It is possible to use only one connected keyboard.

Keyboard Options

– Depending on the country.

Keyboard Language

Specify the keyboard input language.

Keyboard Type

Specify the keyboard type.

Switch Input Language

Configure the key combination used to change the input language.

Device Manager

Keyboard Settings

Mouse Settings

Pointer Settings

– The displayed image may differ depending on the model.

Mouse Settings

Connecting a mouse to the product displays the **Mouse Settings** menu.

Select Mouse

Configure mouse connection settings or options for connected mouse devices.

– Among connected mouse devices, only one mouse can be used.

Mouse Options

– Depending on the country.

Primary Button

Select a button on the mouse that will perform basic functions (click and enter).

- **Left** (default) / **Right**

Pointer Speed

Set the mouse pointer speed.

- **Slow** / **Standard** / **Fast**

A screenshot of a blue settings menu. The menu items are: Device Manager, Keyboard Settings, Mouse Settings, and Pointer Settings. The 'Pointer Settings' item is highlighted with a white border and yellow text.

Pointer Settings

Specify the pointer size, speed and shape.

Pointer Size

Specify the pointer size.

- **Small / Medium / Large / Extra large**

Pointer Speed

Specify the pointer speed. A higher speed increases the pointer sensitivity.

- **Slow / Standard / Fast**



Pointer Image

Specify the pointer shape.

- **Image 1 ~ Image 10**

– The displayed image may differ depending on the model.

Play via

MENU  → System → Play via → ENTER 



– The displayed image may differ depending on the model.

Change PIN

MENU  → System → Change PIN → ENTER 

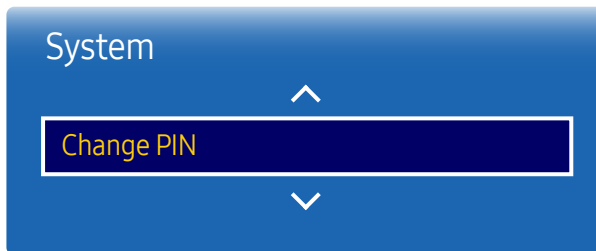

– The displayed image may differ depending on the model.

Select the appropriate **Play via** mode depending on the environment where you are using the product. The home screen may be different depending on the setting.

- **MagicInfo / URL Launcher**



The **Change PIN** screen will appear.

Choose any 4 digits for your PIN and enter it in **Enter New PIN**. Reenter the same 4 digits in **Confirm New PIN**.

When the Confirm screen disappears, press the **Close** button. The product has memorized your new PIN.

– Default password: 0 - 0 - 0 - 0

Security

MENU  → System → Security → ENTER 

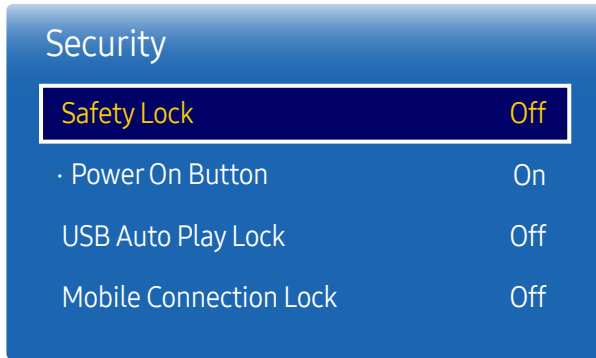

– The displayed image may differ depending on the model.

Safety Lock

– Enter your 4 digit PIN number. The default PIN number is “0-0-0-0”.
If you want to change the PIN number, use the **Change PIN** function.

- **Off / On**

All the menus and buttons of the product and remote control, except for the **LOCK** button on the remote control, will be locked by the **Safety Lock** function.

To unlock the menus and buttons, press the **LOCK** button and then enter the password (default password: 0 - 0 - 0 - 0).

Power On Button

Turn on this feature to enable the remote control's Power button to turn on the device while **Safety Lock** is enabled.

- **Off / On**

USB Auto Play Lock

Select whether to automatically play **MagicInfo** content saved on a connected USB device.

- **Off**
Play **MagicInfo** content saved on the USB device automatically.
- **On**
Do not play **MagicInfo** content saved on the USB device automatically.



– Connecting a USB device containing **MagicInfo** content displays "**USB Auto Play Lock : On**" for five seconds.

Mobile Connection Lock

Restrict other devices on your network, such as smart phones and tablets, to share content with your signage.

- **Off / On**

General

MENU  → System → General → ENTER 

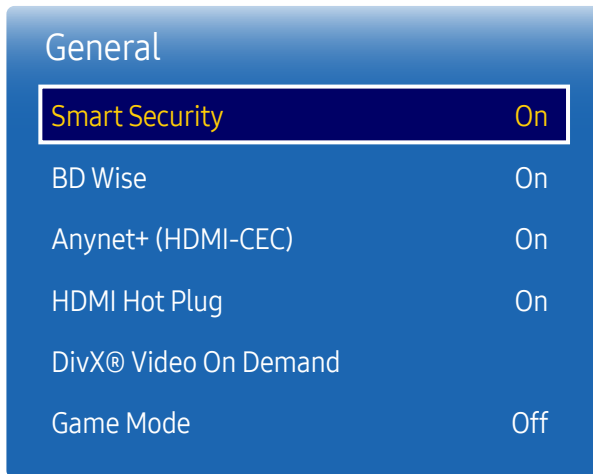

– The displayed image may differ depending on the model.

Smart Security

Security provided to protect your TV and connected storage devices against viruses includes.

Smart Security

Use this option to turn **Smart Security** protection On/Off.

- Off / On

Scan

Inspect the TV and connected storage devices to check for viruses.

Isolated List

This is the list of items that have been Isolated for containing viruses.

Allowed List

This is the list of items that have been Allowed as not containing viruses.

Settings

Set the **Smart Security** options.

Auto Scan

Scan automatically when the TV is turned on.

- Off / On

Move to Isolated List automatically

Moves viruses to the Isolated List automatically.

- Off / On

General

Smart Security	On
BD Wise	On
Anynet+ (HDMI-CEC)	On
HDMI Hot Plug	On
DivX® Video On Demand	
Game Mode	Off

BD Wise

Provides the optimal picture quality for Samsung DVD, Blu-ray and Home Theater products which support **BD Wise**. When **BD Wise** is turned **On**, the picture mode is automatically changed to the optimal resolution.

- **Off / On**
- Available when you connect Samsung products that support **BD Wise** through an HDMI cable to the product.
- The **BD Wise** function is enabled only when a source device with the **BD Wise** function is connected.

– The displayed image may differ depending on the model.

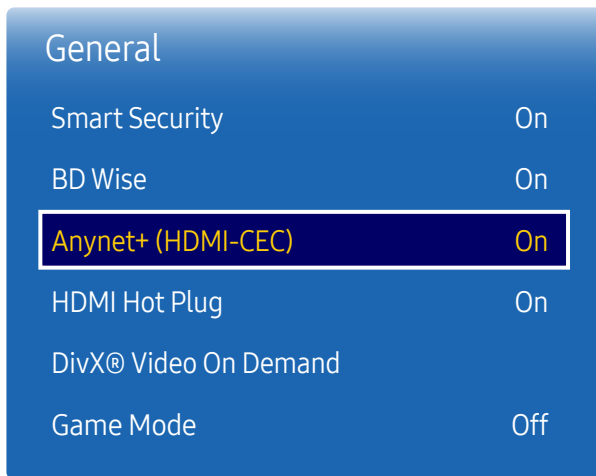

– The displayed image may differ depending on the model.

Anynet+ (HDMI-CEC)

Anynet+ (HDMI-CEC)

Anynet+ is a function that enables you to control all connected Samsung devices that support Anynet+ with your Samsung product remote. The Anynet+ system can be used only with Samsung devices that have the Anynet+ feature. To be sure your Samsung device has this feature, check if there is an Anynet+ logo on it.

- You can only control Anynet+ devices using the product remote control, not the buttons on the product.
- The product remote control may not work under certain conditions. If this occurs, reselect the Anynet+ device.
- **Anynet+** works when the AV device supporting **Anynet+** is in the standby or on status.
- While in **PIP** mode, **Anynet+** functions only when an AV device is connected as the primary display. It does not work if the AV device is connected as a secondary display.
- **Anynet+** supports up to 12 AV devices in total. Note that you can connect up to 3 devices of the same type.

Anynet+ Menu

The **Anynet+** menu changes depending on the type and status of the Anynet+ devices connected to the product.

- Press the **TOOLS** button to display the **Anynet+** menu and select a menu you want.

Anynet+ Menu	Description
View PC	Changes Anynet+ mode to PC mode.
Select Device	Shows the Anynet+ device list.
(device_name) MENU	Shows the menu of the connected device menus. E.g. if a DVD player is connected, the disc menu of the DVD player will appear.
(device_name) Tools	Shows the tools menu of the connected device. E.g. if a DVD player is connected, the tools menu of the DVD player will appear. – Depending on the device, this menu may not be available.
(device_name) Title Menu	Shows the title menu of the disc in the connected device. E.g. if a DVD player is connected, the title menu of the movie in the DVD player will appear. – Depending on the device, this menu may not be available.

Anynet+ (HDMI-CEC)

Anynet+ (HDMI-CEC) On

Auto Turn Off No

Device search

Auto Turn Off

Setting an **Anynet+** Device to turn **Off** automatically when the product is turned off.

- **No / Yes**
- If **Auto Turn Off** is set to **Yes**, running external devices will turn off at the same time as the product powers off.
- May not be enabled depending on the device.

Device search

Switching between Anynet+ Devices

1 Press the **TOOLS** button, select **Anynet+ (HDMI-CEC)**, and then press .

2 Select **Select Device**, and then press the  button.

If you cannot find a device you want, select **Refresh** to refresh the list.

3 Select a device, and then press the  button. You can switch to the selected device.

- The **Select Device** menu appears only when you set **Anynet+ (HDMI-CEC)** to **On** in the **System** menu.
- Switching to the selected device may take up to 2 minutes. You cannot cancel the switching operation while switching is in progress.
- If you have selected an Anynet+ device by pressing the **SOURCE** button and then selecting its input source, you cannot use the **Anynet+** function.
- Make sure to switch to an **Anynet+** device by using the **Select Device**.

— The displayed image may differ depending on the model.

Troubleshooting for Anynet+

Problem	Possible Solution
Anynet+ does not work.	<ul style="list-style-type: none">• Check if the device is an Anynet+ device. The Anynet+ system supports Anynet+ devices only.• Check if the Anynet+ device power cord is properly connected.• Check the Anynet+ device's Video/Audio/HDMI cable connections.• Check whether Anynet+ (HDMI-CEC) is set to On in the System menu.• Check whether the remote control is Anynet+ compatible.• Anynet+ doesn't work in certain situations. (initial setup)• If you have removed and then reconnected the HDMI cable, please make sure to search devices again or turn your product off and on again.• Check if the Anynet+ function of the Anynet device is set on.
I want to start Anynet+.	<ul style="list-style-type: none">• Check if the Anynet+ device is properly connected to the product and check if the Anynet+ (HDMI-CEC) is set to On in the System menu.• Press the TOOLS button to display the Anynet+ menu and select a menu you want.
I want to exit Anynet+.	<ul style="list-style-type: none">• Select View PC in the Anynet+ menu.• Press the SOURCE button on the product remote control and select a non- Anynet+ device.
The message " Disconnecting Anynet+ device ... " appears on the screen.	<ul style="list-style-type: none">• You cannot use the remote control when you are configuring Anynet+ or switching to a view mode.• Use the remote control after the product has completed Anynet+ configuration or has finished switching to Anynet+.
The Anynet+ device does not play.	<ul style="list-style-type: none">• You cannot use the play function when initial setup is in progress.

Problem

Possible Solution

The connected device is not displayed.

- Check whether or not the device supports Anynet+ functions.
 - Check whether or not the HDMI cable is properly connected.
 - Check whether **Anynet+ (HDMI-CEC)** is set to **On** in the **System** menu.
 - Search Anynet+ devices again.
 - Anynet+ requires an HDMI connection. Make sure the device is connected to your product with an HDMI cable.
 - Some HDMI cables may not support Anynet+ functions.
 - If the connection is terminated because there has been a power failure or the HDMI cable has been disconnected, please repeat the device scan.
-

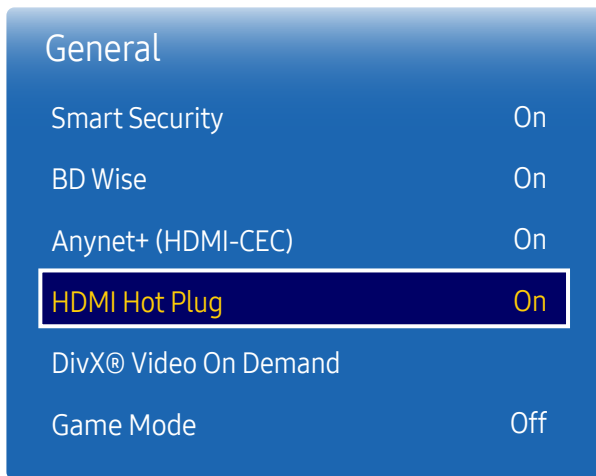

General	
Smart Security	On
BD Wise	On
Anynet+ (HDMI-CEC)	On
HDMI Hot Plug	On
DivX® Video On Demand	
Game Mode	Off

– The displayed image may differ depending on the model.

HDMI Hot Plug

This feature is used to activate the time delay to turn on a DVI/HDMI source device.

- Off / On

DivX® Video On Demand

Shows the registration code authorized for the product.

If you connect to the DivX® web site and register using that code, you can download the VOD registration file.

For more information about DivX® VOD, visit "<http://vod.divx.com>".

Game Mode

When connecting to a game console such as PlayStation™ or Xbox™, you can enjoy a more realistic gaming experience by selecting game mode.

- Off / On

— Precautions and limitations for **Game Mode**

To disconnect the game console and connect another external device, set **Game Mode** to **Off** in the setup menu.

Reset System

This option returns the current settings under system to the default factory settings.

MENU  → System → Reset System → ENTER 

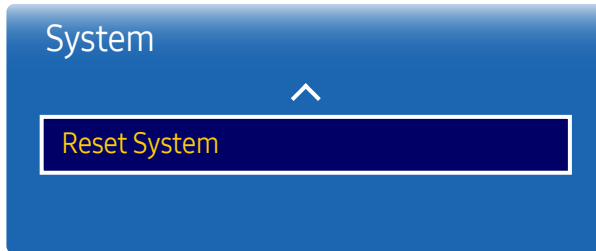

– The displayed image may differ depending on the model.

Chapter 11

Support

Software Update

MENU  → Support → Software Update → ENTER 

The **Software Update** menu lets you upgrade your product software to the latest version.

- Be careful not to turn off the power until the upgrade is complete. The product will turn off and on automatically after completing the software upgrade.
- When you upgrade software, all video and audio settings you have made will return to their default settings. We advise you to write down your settings so that you can easily reset them after the upgrade.

Update now

Update the software to the latest version.

- **Current version:** This is the software version already installed in the product.

Auto Update

This feature automatically updates the product when not in use.

- Off / On

Contact Samsung

MENU  → Support → Contact Samsung → ENTER 

View this information when your product does not work properly or when you want to upgrade the software.

You can find information regarding our call centers and how to download products and software.

- **Contact Samsung** and find the product **Model Code** and **Software Version**.



Go to Home

Accessible using the HOME  button on the remote control.

MENU  → Support → Go to Home → ENTER 

Go to Home to play a variety of content from a memory device or a connected network.

Reset All

MENU  → Support → Reset All → ENTER 

This option returns all the current settings for a display to the default factory settings.

Chapter 12

Playing photos, videos and music (Media Play)

Enjoy videos, photos, music files saved on a USB Mass Storage Class (MSC) device.

Play photos, videos or music saved on a storage device.

Play a variety of content using the following methods.

- Using a USB device: Play media content such as videos, photos and music from a USB device.
- Connecting a storage device: Play media content saved on a storage device such as a smartphone, camera, PC or cloud service.

Read the following before using media play with a USB device

Caution

- Before connecting a USB device to the product, back up files to ensure your data is not damaged or lost. Samsung Electronics is not liable for any damage or loss of data.
- Do not remove a USB device while it is loading.
- If a USB device is connected using a USB extension cable, the USB device may not be recognized or files saved on the device may not be able to be read.
- If the product does not recognize a connected USB device, the files on the USB device may be corrupted or may not be able to be played. If this occurs, connect the USB device to the PC to format the device, then make sure the device is connected properly.
- USB HDD greater than 2TB is not supported.

Compatible devices with media play

- Some USB digital cameras, smartphones and audio devices may not be compatible with the product.
- Media play is only compatible with USB MSC devices.
- MSC device refers to a Mass Storage Class Bulk-Only Transport device.
Examples of MSC devices include Thumb drives, Flash card readers and USB HDDs. (USB hubs are not supported.)
These MSC devices must be connected directly to a USB port on the product.
- If more than one Picture Transfer Protocol (PTP) device is connected, only one will work at a time.
- If multiple MSC devices are connected, some devices may not be recognized. USB devices that require high power (higher than 500mA or 5V) may not be supported.
- If an overheating warning message appears when a USB device is connected or used, the USB device may not be recognized or function properly.
- The screensaver activates if the product is left idle for a period of time specified in **Auto Protection Time**.
- Power-saving mode on some external hard disk drives may automatically deactivate after connecting to the product.

File system and formats

- Media play may not function properly with unlicensed multimedia files.
- Media Transfer Protocol (MTP) is not supported.
- Supported file systems include FAT16, FAT32 and NTFS (read only).
- Media play supports the sequential JPEG format.
It does not support the progressive JPEG format.
- Images with a higher resolution take longer to be displayed on the screen.
- The maximum JPEG resolution supported is 15360x8640 pixels.
- If a file is incompatible or corrupted, a message **Not Supported File Format** appears.
- When sorting files in folder view mode, a maximum of 1000 files can be displayed in each folder.
- If a USB device contains 8000 files and folders or more, some files and folders may not open.
- DRM MP3 files downloaded from websites that charge a fee cannot be played.
Digital Rights Management (DRM) refers to a system for protecting the copyrights of data circulated via the Internet or other digital media by enabling secure distribution and/or disabling illegal distribution of the data.

Using a USB device

Connecting a USB device

- 1 Turn on your product.
- 2 Connect a USB device containing photo, music and/or movie files to the USB port on the back or side panel of the product.
- 3 The **Player** page automatically appears as soon as a USB device connects to the product.
 - If only one USB device is connected, files saved on the USB device are displayed automatically.
 - To view content saved on a USB device, connect the USB device to a USB port on the product.

Removing a USB device

Removing a USB device from Source

- 1 Press **SOURCE** on the remote control. Alternatively, go to **Source** using the OSD menu.
SOURCE → **Source**
- 2 Select **USB** from **Source**, and then press the **TOOLS** button on the remote control. The **Options** menu is displayed.
- 3 Select **Disconnect USB Device** and wait until the USB device is disconnected. The USB device is disconnected.

It is recommended to use a USB HDD that has a power adapter.

It is recommended to remove a USB device using the **Disconnect USB Device** function.

Playing media content from a PC/mobile device

Approving a PC/mobile device connection

Play photos, videos or music saved on a PC or mobile device.

To play media content from a PC or mobile device on the product, the connection with the PC or mobile device must be approved.

1 Press **SOURCE** on the remote control. Alternatively, go to **Source** using the OSD menu.

SOURCE → **Source**

2 Select **Network** from **Source**. The **Network Device** menu appears.

3 Select **Options** from the screen, and then select **Multimedia Device Settings**. A list of devices connected to the product will appear.

4 Select a device and approve the device connection. Playback is only available on devices that are permitted to connect.

— Sending a media content playback request from a PC or mobile device displays a prompt asking if connection with the product is permitted. Conveniently connect the devices using the prompt.

— For details on how to configure a network, refer to the section **Network Settings**.

— Ensure the product and PC are connected to the same network subnet.

All IP addresses are made up of four parts separated by dots.

(E.g. IP address 111.222.333.444) The product should have the same IP address as the PC, except for the fourth part of the address, if they are connected to the same subnet. (E.g. 111.222.333.***)

Features provided in the media content list page

SOURCE → Source → USB

The media content list page on a storage device provides the following features.

- **Sort by**
Rearrange the media content list under the selected file format in a desired view mode.
 - This menu item is not available if **Filter** is set to **All**.
- **Filter**
Among **Photos**, **Videos** and **Music** content saved on a storage device, view content files under a desired file format only.
- **Options**
 - This menu item is not available if **Filter** is set to **All**.

Menu items in the media content list page

Option Name	Operations	Photos	Videos	Music
Slide Show	Start a slideshow. — This menu item is not available if Sort by is set to Folder .	✓		
Encoding	Select an encoding language if the title of media content appears corrupted.			✓
Rename Playlist	Rename a playlist. — This option is activated if content is added to a playlist, using the Add to Playlist menu.			✓
Delete Playlist	Delete a playlist. — This option is activated if content is added to a playlist, using the Add to Playlist menu.			✓
Add to Playlist	Add files to a playlist or create a new playlist.			✓
Play Selected	Select and play desired content from the media content list.	✓	✓	✓
Send	Send media content to another storage device. This is similar to the "copy" feature on PCs.	✓	✓	✓
Index	Select an index to conveniently locate media content if a storage device contains a lot of media content. — Provided indices include dates and alphanumeric characters. — This menu item is not available if Sort by is set to Folder .	✓	✓	✓

Available buttons and features during photo playback

Pressing the  or TOOLS button displays the following buttons. The RETURN button makes the buttons disappear.





- **Pause / Play**
Start or stop a slideshow. Using a slideshow, it is possible to play all photos in a folder.
- **Previous / Next**
View the previous or next photo.
- **Settings**

- Pressing the INFO button while a device name is selected will display information about the selected device.
- Pressing the INFO button while a file is selected will display information about the selected file.

Option Name	Operations
Slideshow Settings	Speed: Change the slideshow speed. Effects: Apply transition effects between photos.
Rotate	Rotate photos.
Zoom	Zoom in on photos up to 4x.
Picture Mode	Change the Picture Mode .
Background Music	Play background music while viewing photos. <ul style="list-style-type: none">— Make sure a music file is saved on the same device.— The mini player is displayed while background music (Background Music) is playing. Using the mini player, pause the music currently playing or change to another music.<ul style="list-style-type: none">— Previous BGM track / Pause BGM / Play BGM / Next BGM track
Select Speakers	Select a speaker that will output the background music (Background Music). <ul style="list-style-type: none">— This menu item is only available when background music (Background Music) is playing.
Send	Send open photos to another storage device. This is similar to the "copy" feature on PCs.
Information	View information about a file.





Available buttons and features during video playback

Pressing the  or TOOLS button displays the following buttons. The RETURN button makes the buttons disappear.

- **Pause / Play**
Pause or play a video.
The following features are available in pause mode. Note that sound cannot be heard in pause mode.
- **Rewind / Fast forward**
Rewind or fast forward a video. Speed up playback up to 3x, if required. To change the playback speed to the original speed, select .
- **Previous / Next**
To play the previous video, select  twice. Selecting  once will play the current video from the beginning.
To play the next video, select .
- **Settings**

Option Name	Operations
Select Scene	Thumbnails: Select a scene and play the video from the scene. — Thumbnails is not available if 1) the thumbnail of the video is not extracted yet, 2) the video contains audio only or 3) the video play time is shorter than 60 seconds. Chapter Titles: Select and play another video in the same folder. Time Bar: You can use the ◀ and ▶ buttons to scan through the file in 10-second intervals or enter a specific time value to jump to that point in the video.
Subtitle	Language / Sync / Reset Sync / Size / Encoding — If the subtitle is displayed incorrectly, change Encoding options.
Repeat	Configure Repeat . Off Repeat One: Play the current video repeatedly. Repeat All: Play all videos in a folder repeatedly.
Rotate	Rotate an image.
Picture Size	Change the screen size (Picture Size). Supported screen sizes vary depending on the image.
Picture Mode	Change the Picture Mode .
Select Speakers	Select a speaker that will output sound from the product.
Audio Language	Play a video using a desired language. This feature only activates when a streaming file that supports multiple audio formats is playing.
Information	View information about a file.

Available buttons and features during music playback

- **Pause / Play**
Pause or play music.
- **Rewind / Fast forward**
Rewind or fast forward music. Speed up playback up to 3x, if required. To play the previous music file, select  twice.
- **Previous / Next**
To play the previous music file, select  twice. Selecting  once will play the current music from the beginning.
To play the next music file, select .
- **Repeat**
Configure **Repeat** mode. **Repeat One** plays the current music file repeatedly. **Repeat All** plays all files in a folder repeatedly.
- **Shuffle**
Enable or disable shuffle playback mode.

Supported Subtitle and Media play file formats

Subtitle

External

- MPEG-4 timed text (.txt)
- SAMI (.smi)
- SubRip (.srt)
- SubViewer (.sub)
- Micro DVD (.sub or .txt)
- SubStation Alpha (.ssa)
- Advanced SubStation Alpha (.ass)
- Powerdivx (.psb)

Internal

- Xsub
Container: AVI
 - SubStation Alpha
Container: MKV
 - Advanced SubStation Alpha
Container: MKV
 - SubRip
Container: MKV
 - MPEG-4 timed text
Container: MP4
-

Supported image resolutions

File Extension	Type	Resolution
*.jpg, *.jpeg	JPEG	15360 x 8640
*.png	PNG	1920 x 1080
*.bmp	BMP	1920 x 1080
*.mpo	MPO	15360 x 8640

Supported music file formats

File Extension	Type	Codec	Comments
*.mp3	MPEG	MPEG1 Audio Layer 3	
*.m4a, *.mpa, *.aac, *.3ga	MPEG4	AAC	
*.flac	FLAC	FLAC	The Seek (jump) function is not supported. Supports up to 2 channel

Supported Video Formats

- Video content will not play, or not play correctly, if there is an error in the content or the container.
- Sound or video may not work if the contents have a standard bitrate/frame rate above the compatible Frame/sec listed in the table above.
- If the Index Table is in error, the Seek (Jump) function is not supported.
- You may experience file stuttering while playing a video through a network connection.
- The menu may take longer to appear if the video's bit rate exceeds 10Mbps.
- Some USB/digital camera devices may not be compatible with the player.

Video Decoder

Supports up to H.264, Level 4.1

H.264 FMO / ASO / RS, VC1 SP / MP / AP L4 and AVCHD are not supported.

For all Video codecs except MVC, VP8, VP6:

- Below 1280 x 720: 60 frame max
- Above 1280 x 720: 30 frame max

GMC 2 over is not supported.

Supports only BD MVC Spec.

Audio Decoder

Supports up to WMA10 Pro 5.1 channel.

WMA lossless audio is not supported.

QCELP, AMR NB/WB are not supported.

If Vorbis is only in Webm container, supports up to 2 channel.

File Extension	Container	Video Codec	Resolution	Frame rate (fps)	Bit rate (Mbps)	Audio Codec
*.avi	AVI	DivX 3.11 / 4.x / 5.x / 6.x	1920 x 1080	6~30	30	AC3
*.mkv	MKV					LPCM
*.asf	ASF					ADMP3
*.wmv	MP4	MPEG4 SP / ASP				(IMA, MS)
*.mp4	3GP					AAC
*.mov	VRO	H.264 BP / MP / HP				HE-AAC
*.3gp	VOB					WMA
*.vro	PS					DD+
*.mpg	TS	Motion JPEG				MPEG(MP3)
*.mpeg						DTS Core
*.ts		Window Media Video v9				G.711(ALaw,μ-Law)
*.tp						
*.trp						
*.mov		MPEG2				
*.flv						
*.vob		MPEG1				
*.svi		VP6	640 x 480		4	
*.m2ts						
*.mts		MVC	1920 x 1080	24 / 25 / 30	40	
*.divx						
*.webm	WebM	VP8		6 ~ 30	8	Vorbis

Chapter 13

Troubleshooting Guide

Before calling Samsung Customer Service Center, test your product as follows. If the problem persists, contact Samsung Customer Service Center.

If the screen remains blank, check the PC system, video controller and cable.

Requirements Before Contacting Samsung Customer Service Center

Testing the Product

Check if your product is operating normally by using the product test function.

If the screen remains blank while the power LED blinks even when the product is correctly connected to a PC, perform product testing.

- 1 Power off both the PC and product.
- 2 Disconnect all the cables from the product.
- 3 Power on the product.
- 4 If **No Signal** is displayed, the product is operating normally.

Checking the Resolution and Frequency

Not Optimum Mode will briefly be displayed if a mode that exceeds a supported resolution is selected (refer to Supported Resolutions).

Check the followings.

Installation issue (PC mode)

The screen keeps switching on and off.	Check the cable connection between the product and PC, and ensure the connection is secure.
Blank spaces are found on all four sides of the screen when an HDMI or HDMI-DVI cable is connected to the product and PC.	<p>The blank spaces found on the screen have nothing to do with the product.</p> <p>Blank spaces on the screen are caused by the PC or graphics card. To resolve the problem, adjust the screen size in the HDMI or DVI settings for the graphics card.</p> <p>If the graphics card settings menu does not have an option to adjust the screen size, update the graphics card driver to the latest version.</p> <p>(Please contact the graphics card or computer manufacturer for further details about how to adjust the screen settings.)</p>
PC is shown in Source when a PC is not connected.	PC is always shown in Source irrespective of whether or not a PC is connected.

Screen issue

The power LED is off. The screen will not switch on.	Make sure that the power cord is connected.
No Signal is displayed on the screen.	<p>Check that the product is connected correctly with a cable.</p> <p>Check that the device connected to the product is powered on.</p>
Not Optimum Mode is displayed.	<p>This message is displayed when a signal from the graphics card exceeds the product's maximum resolution and frequency.</p> <p>Refer to the Standard Signal Mode Table and set the maximum resolution and frequency according to the product specifications.</p>
The images on the screen look distorted.	Check the cable connection to the product

Screen issue

The screen is not clear. The screen is blurry.	Adjust Coarse and Fine . Remove any accessories (video extension cable, etc) and try again. Set the resolution and frequency to the recommended level.
The screen appears unstable and shaky. There are shadows or ghost images left on the screen.	Check that the resolution and frequency of the PC and graphics card are set within a range compatible with the product. Then, change the screen settings if required by referring to the Additional Information on the product menu and the Standard Signal Mode Table.
The screen is too bright. The screen is too dark.	Adjust Brightness and Contrast .
Screen color is inconsistent.	Go to Picture and adjust the Color Space settings.
White does not really look white.	Go to Picture and adjust the White Balance settings.
There is no image on the screen and the power LED blinks every 0.5 to 1 second.	The product is in power-saving mode. Press any key on the keyboard or move the mouse to return to the previous screen.
The product will turn off automatically.	Go to System and make sure Sleep Timer is set to Off . If a PC is connected to the product, check the power status of the PC. Make sure the power cable is connected properly to the product and power outlet. If the signal from a connected device is not detected, the product automatically turns off after 10 to 15 minutes.
Picture quality of the product is different from the dealer shop where it was purchased.	Use an HDMI cable to obtain high-definition (HD) picture quality.
The screen display does not look normal.	Encoded video content may cause the display to appear corrupted in scenes featuring fast moving objects such as in a sports event or action video. Low signal level or low picture quality may cause the display to appear corrupted. This does not mean the product is defective. A cell phone within a distance of one-meter radius may cause static on analog and digital products.

Screen issue

The brightness and color do not look normal.	Go to Picture and adjust the screen settings such as Picture Mode , Color , Brightness and Sharpness .
	Go to System and adjust the Energy Saving settings.
	Reset the screen settings to the default settings.
Broken lines are displayed on the edges of the screen.	If Picture Size is set to Screen Fit , change the setting to 16:9 .
Lines (red, green or blue) are displayed on the screen.	These lines are displayed when there is a defect in DATA SOURCE DRIVER IC on the monitor. Contact a Samsung Service Center to resolve the issue.
The display looks unstable and then freezes.	The screen may freeze when a resolution other than the recommended resolution is used or if the signal is not stable. To resolve the issue, change the PC resolution to the recommended resolution.
The screen cannot be displayed in full screen.	A scaled SD (4:3) content file can cause black bars on both sides of an HD channel screen.
	A video with an aspect ratio different from the product can cause black bars at the top and bottom of the screen.
	Change the screen size setting to full screen on the product or source device.

Sound issue

There is no sound.

Check the connection of the audio cable or adjust the volume.

Check the volume.

The volume is too low.

Adjust the volume.

If the volume is still low after turning it up to the maximum level, adjust the volume on your PC sound card or software program.

Video is available but there is no sound.

If an HDMI cable is connected, check the audio output settings on the PC.

If a source device is used

- Make sure the audio cable is properly connected to the audio input port on the product.
 - Check the audio output settings for the source device.
(For example, if an HDMI cable is connected to the monitor, the audio setting for the cable box may need to be changed to HDMI.)
-

If a DVI-HDMI cable is used, a separate audio cable is required.

If the product has a headphone port, make sure nothing is connected to it.

Reconnect the power cable to the device and then reboot the device.

There is static coming from the speakers.

Check the cable connection. Make sure a video cable is not connected to an audio input port.

Check the signal strength after connecting a cable.

Low signal level can cause corrupted sound.

Remote control issue

The remote control does not work.

Make sure that the batteries are correctly in place (+/-).

Check if the batteries are flat.

Check for power failure.

Make sure that the power cord is connected.

Check for any special lighting or neon signs switched on in the vicinity.

Source device issue

A beeping sound is heard when my PC is booting.

If a beeping sound is heard when your PC is booting, have your PC serviced.

Other issue

The product smells like plastic.	The plastic smell is normal and disappears over time.									
The monitor appears tilted.	Remove and then attach the stand again to the product.									
Audio or video cuts out intermittently.	<p>Check the cable connection and connect it again if required.</p> <p>Using a very hard or thick cable may corrupt audio and video files.</p> <p>Make sure cables are flexible enough to ensure durability. When mounting the product onto a wall, it is recommended to use right-angle cables.</p>									
Small particles are found on the edges of the product.	The particles are part of the product design. The product is not defective.									
When I try to change the PC resolution, a message " The defined resolution is not currently supported. " appears.	<p>The message "The defined resolution is not currently supported." appears if the input source resolution exceeds the maximum resolution of the display.</p> <p>To resolve the issue, change the PC resolution to a resolution supported on the display.</p>									
There is no sound from the speakers in HDMI mode when a DVI-HDMI cable is connected.	<p>DVI cables do not transmit sound data.</p> <p>Make sure to connect the audio cable to the correct input jack to enable audio.</p>									
HDMI Black Level is not functioning properly on an HDMI device with YCbCr output.	This function is available only when a source device, such as a DVD player and STB, is connected to the product via an HDMI (RGB signal) cable.									
There is no sound in HDMI mode.	<p>Displayed picture colors may not look normal. Video or sound may not be available. This can occur if a source device that only supports an older version of the HDMI standard is connected to the product.</p> <p>If these issues occur, connect an audio cable along with the HDMI cable.</p> <p>Some PC graphics cards may not automatically recognize HDMI signals that do not include sound. In this case, manually select a sound input.</p> <table border="1"> <thead> <tr> <th></th> <th>Sound input</th> <th>Screen mode</th> </tr> </thead> <tbody> <tr> <td>PC</td> <td>Auto</td> <td>PC settings</td> </tr> <tr> <td>DVI PC</td> <td>Audio In (Stereo ports)</td> <td>PC settings</td> </tr> </tbody> </table>		Sound input	Screen mode	PC	Auto	PC settings	DVI PC	Audio In (Stereo ports)	PC settings
	Sound input	Screen mode								
PC	Auto	PC settings								
DVI PC	Audio In (Stereo ports)	PC settings								

Other issue

The IR sensor is not functioning.	Make sure the sensor light turns on when a button is pressed on the remote control.
In power-saving mode, when the input source is DisplayPort , PC display settings cannot be saved.	Go to System → Power Control and set Max. Power Saving to Off . Alternatively, configure the PC display output settings again. Ensure the set is turned on.
When booting the PC with the input source set to DisplayPort , the BIOS and booting screens do not appear.	Boot the PC when the set is turned on or when the input source is not DisplayPort .

Q & A

Question

How can I change the frequency?

– Refer to the user manual for your PC or graphics card for further instructions on adjustment.

Answer

Set the frequency on your graphics card.

- Windows 7: Go to **Control Panel** → **Appearance and Personalization** → **Display** → **Adjust resolution** → **Advanced Settings** → **Monitor** and adjust the frequency in **Monitor Settings**.
- Windows 8: Go to **Settings** → **Control Panel** → **Appearance and Personalization** → **Display** → **Adjust resolution** → **Advanced Settings** → **Monitor** and adjust the frequency in **Monitor Settings**.
- Windows 10: Go to **Settings** → **System** → **Display** → **Advanced display settings** → **Display adapter properties** → **Monitor**, and adjust **Screen refresh rate** under **Monitor settings**.

How can I change the resolution?

- Windows 7: Go to **Control Panel** → **Appearance and Personalization** → **Display** → **Adjust Resolution** and adjust the resolution.
- Windows 8: Go to **Settings** → **Control Panel** → **Appearance and Personalization** → **Display** → **Adjust Resolution** and adjust the resolution.
- Windows 10: Go to **Settings** → **System** → **Display** → **Advanced display settings**, and adjust the resolution.

How do I set powersaving mode?

- Windows 7: Set power-saving mode in **Control Panel** → **Appearance and Personalization** → **Personalize** → **Screen Saver Settings** or **BIOS SETUP** on the PC.
 - Windows 8: Set power-saving mode in **Settings** → **Control Panel** → **Appearance and Personalization** → **Personalize** → **Screen Saver Settings** or **BIOS SETUP** on the PC.
 - Windows 10: Set power-saving mode in **Settings** → **Personalization** → **Lock screen** → **Screen timeout settings** → **Power & sleep** or **BIOS SETUP** on the PC.
-

Chapter 14

Specifications

– Size

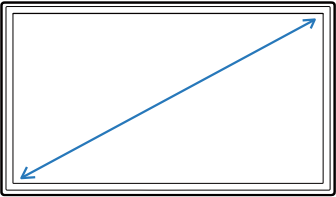

– Display area

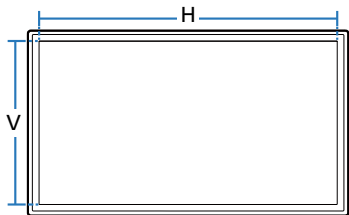

General

Model Name **SH37F**

Panel	Size	37 CLASS (37.0 inches / 93.9 cm)
	Display area	899.712 mm (H) x 253.044 mm (V) 35.42 inches (H) x 9.96 inches (V)
Power Supply		AC 100 to 240 VAC (+/- 10%), 60 / 50 Hz ± 3 Hz Refer to the label at the back of the product as the standard voltage can vary in different countries.
Environmental considerations	Operating	Temperature : 32 °F – 104 °F (0 °C – 40 °C) * For installing the housing, keep the internal temperature at 40 °C or below. Humidity : 10 % – 80 %, non-condensing
	Storage	Temperature : -4 °F – 113 °F (-20 °C – 45 °C) Humidity : 5 % – 95 %, non-condensing

— Plug-and-Play

This monitor can be installed and used with any Plug-and-Play compatible systems. Two-way data exchange between the monitor and PC system optimizes the monitor settings. Monitor installation takes place automatically. However, you can customize the installation settings if desired.

— Due to the nature of the manufacturing of this product, approximately 1 pixel per million (1ppm) may appear brighter or darker on the panel. This does not affect product performance.

— This is a class A product. In a domestic environment this product may cause radio interference in which case the user may be required to take adequate measures.

— For detailed device specifications, visit the Samsung Electronics website.

(USA only)

Dispose unwanted electronics through an approved recycler.

To find the nearest recycling location, go to our website: www.samsung.com/recyclingdirect or call, (877) 278 - 0799

Preset Timing Modes

- This product can be set to only one resolution for each screen size to obtain the optimum picture quality due to the nature of the panel. Using a resolution other than the specified resolution may degrade the picture quality. To avoid this, it is recommended that you select the optimum resolution specified for your product.
- Check the frequency when you exchange a CDT product (connected to a PC) for an LCD product. If the LCD product does not support 85Hz, change the vertical frequency to 60Hz using the CDT product before you exchange it with the LCD product.

Model Name		SH37F
Synchronization	Horizontal Frequency	26 - 81 kHz
	Vertical Frequency	50 - 75 Hz
Resolution	Optimum resolution	1920 x 540 @ 60 Hz
	Maximum resolution	1920 x 1080 @ 60 Hz

The screen will automatically be adjusted if a signal that belongs to the following standard signal modes is transmitted from your PC. If the signal transmitted from the PC does not belong to the standard signal modes, the screen may be blank with the power LED on. In such a case, change the settings according to the following table by referring to the graphics card user manual.

Resolution	Horizontal Frequency (kHz)	Vertical Frequency (Hz)	Pixel Clock (MHz)	Sync Polarity (H/V)
IBM, 720 x 400	31.469	70.087	28.322	-/+
MAC, 640 x 480	35.000	66.667	30.240	-/-
MAC, 832 x 624	49.726	74.551	57.284	-/-
MAC, 1152 x 870	68.681	75.062	100.000	-/-
VESA, 640 x 480	31.469	59.940	25.175	-/-
VESA, 640 x 480	37.861	72.809	31.500	-/-
VESA, 640 x 480	37.500	75.000	31.500	-/-

- Horizontal Frequency
The time required to scan a single line from the left to the right side of the screen is called a horizontal cycle. The reciprocal number of a horizontal cycle is called horizontal frequency. Horizontal frequency is measured in kHz.
- Vertical Frequency
The product displays a single image multiple times per second (like a fluorescent light) to display what the viewer sees. The rate of a single image being displayed repeatedly per second is called vertical frequency or refresh rate. Vertical frequency is measured in Hz.

Resolution	Horizontal Frequency (kHz)	Vertical Frequency (Hz)	Pixel Clock (MHz)	Sync Polarity (H/V)
VESA, 800 x 600	35.156	56.250	36.000	+/+
VESA, 800 x 600	37.879	60.317	40.000	+/+
VESA, 800 x 600	48.077	72.188	50.000	+/+
VESA, 800 x 600	46.875	75.000	49.500	+/+
VESA, 1024 x 768	48.363	60.004	65.000	-/-
VESA, 1024 x 768	56.476	70.069	75.000	-/-
VESA, 1024 x 768	60.023	75.029	78.750	+/+
VESA, 1152 x 864	67.500	75.000	108.000	+/+
VESA, 1280 x 720	45.000	60.000	74.250	+/+
VESA, 1280 x 800	49.702	59.810	83.500	-/+
VESA, 1280 x 1024	63.981	60.020	108.000	+/+
VESA, 1280 x 1024	79.976	75.025	135.000	+/+
VESA, 1366 x 768	47.712	59.790	85.500	+/+
VESA, 1440 x 900	55.935	59.887	106.500	-/+
VESA, 1600 x 900 RB	60.000	60.000	108.000	+/+
VESA, 1680 x 1050	65.290	59.954	146.250	-/+
VESA, 1920 x 540	27.917	49.940	67.000	-/+
VESA, 1920 x 540	33.614	59.812	81.750	-/+
VESA, 1920 x 1080	67.500	60.000	148.500	+/+

Chapter 15

Appendix

Responsibility for the Pay Service (Cost to Customers)

— When the service is requested, in spite of in warranty, we may charge you for a visit from a service technician in the following cases.

Not a product defect

Cleaning of the product, Adjustment, Explanation, Re-installation and etc.

- If a service technician gives instructions on how to use product or simply adjusts options without disassembling product.
- If a defect is caused by external environmental factors (Internet, Antenna, Wired Signal, etc.)
- If a product is reinstalled or devices are connected additionally after installing the purchased product for the first time.
- If a product is reinstalled to move to a different spot or to move to a different house.
- If customer requests instructions on how to use because of another company's product.
- If customer requests instructions on how to use the network or another company's program.
- If customer requests software installation and setup for the product.
- If a service technician removes/cleans dusts or foreign materials inside of the product.
- If customer requests an installation additionally after purchasing a product through home-shopping or online.

A Product damage caused by customer's fault

Product damage caused by customer's mishandling or wrong repair

If a product damage is caused by;

- External impact or drop.
- Use of supplies or separately sold product unspecified by Samsung.
- Repair from a person besides an engineer of outsourcing service company or partner of Samsung Electronics Co., Ltd.
- Remodeling or repairing the product by customer.
- Using it with incorrect voltage or non-authorized electrical connections.
- Not following the "cautions" in User Manual.

Others

- If product fails by natural disaster. (lightning, fire, earthquake, flood damage, etc)
 - If consumable components are all used up. (Battery, Toner, Fluorescent lights, Head, Vibrator, Lamp, Filter, Ribbon, etc.)
- If customer requests a service in case the product has no defect, service fee may be charged. So please read User Manual first.

Optimum Picture Quality and Afterimage Burn-in Prevention

Optimum Picture Quality

- Due to the nature of the manufacturing of this product, approximately 1 pixel per million (1ppm) may be brighter or darker on the panel. This does not affect product performance.
 - The number of sub-pixels by panel type: 6,220,800
- Run **Auto Adjustment** to improve the picture quality. If noise is still found even after auto adjustment, adjust **Coarse** or **Fine**.
- Leaving the screen fixed on a stationary image for an extended period of time may cause afterimage burn-in or defective pixels.
 - Activate power-saving mode or a dynamic screen saver if you will not be using the product for an extended period of time.

Prevention of Afterimage Burn-in

What is afterimage burn-in?

Afterimage burn-in should not occur when the LCD panel is operating normally. Normal operation refers to a continuously changing video pattern. If the LCD panel displays a fixed pattern for an extended period of time (more than 12 hours), a slight voltage difference may occur between the electrodes in pixels that control the liquid crystals.

Such a voltage difference between electrodes increases with time and makes the liquid crystals thinner. When this occurs, a previous image can remain on the screen when the pattern changes. To prevent this, the accumulated voltage difference should be reduced.

— Afterimage burn-in should not occur when an LCD panel is operating in proper conditions.

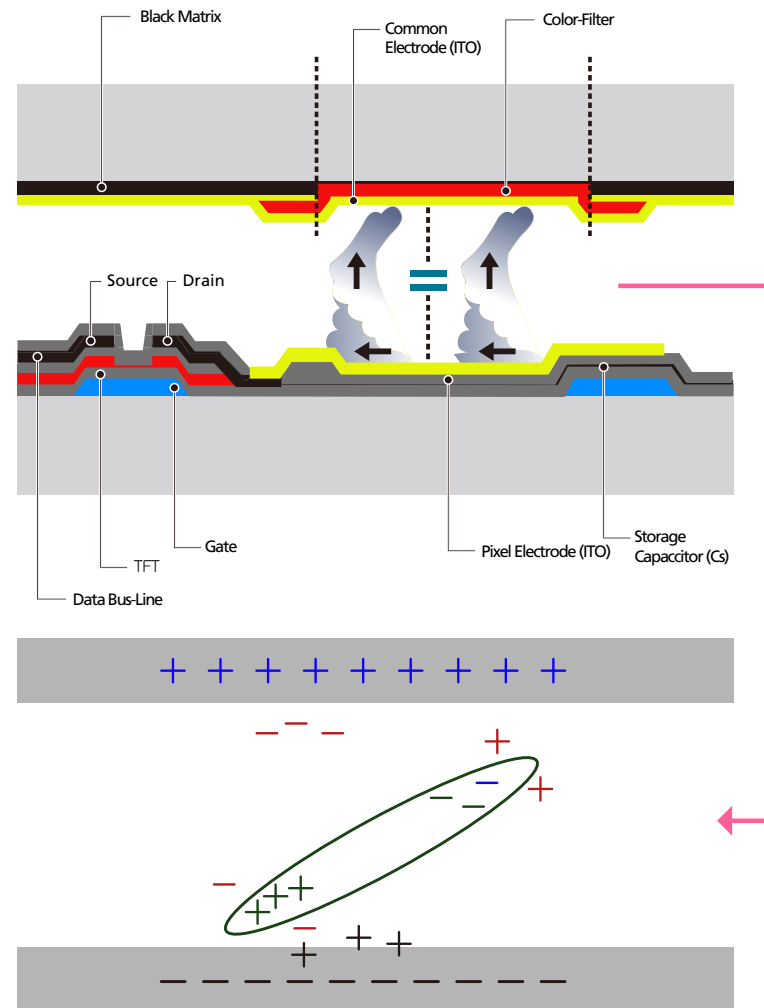

Preventing afterimage burn-in

— The best way to protect the product from afterimage burn-in is switching the power off or setting the PC or system to run a screen saver when not in use. Also, Warranty service may be limited depending on instruction guide.

- Powering Off, Screen Saver and Power Saving Mode
 - Power off the product for 2 hours after using it for 12 hours.
 - Go to Display Properties > Power Supply on your PC and set the product to power off as required.
 - Using a screen saver is recommended.
It is best to use a single-color or moving-image screen saver.
- Regular color Change
 - Use 2 colors
 - Switch between 2 colors every 30 minutes as shown above.

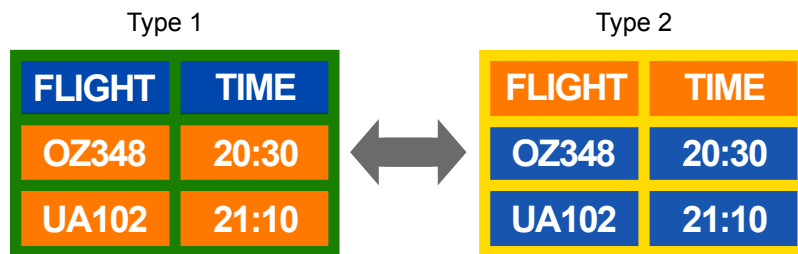

- Avoid combinations of a text color and background color of contrasting brightness. (Brightness: refers to the lightness or darkness of a color which varies depending on the amount of light emitted.)

— Avoid using gray as it may contribute to afterimage burn-in.
— Avoid using colors of contrasting brightness (black and white; gray).



- Regular Text color Change
 - Use bright colors of similar brightness.
 - Interval: Change text color and background color every 30 minutes



- Move and change text every 30 minutes as shown below.

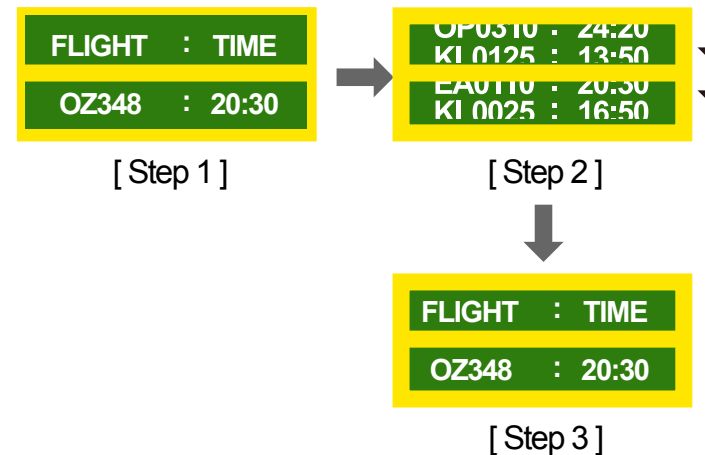

- Regularly display a moving image along with a logo.
Interval: Display a moving image along with a logo for 60 seconds after using for 4 hours.

License



Manufactured under license from Dolby Laboratories.
Dolby and the double-D symbol are trademarks of Dolby Laboratories.



Manufactured under a license from U.S. Patent No's: 5,956,674, 5,974,380, 5,978,762, 6,487,535, 6,226,616, 7,212,872, 7,003,467, 7,272,567, 7,668,723, 7,392,195, 7,930,184, 7,333,929 and 7,548,853. DTS, the Symbol, and DTS and the Symbol together are registered trademarks & DTS Premium Sound is a trademark of DTS, Inc. ©2012 DTS, Inc. All Rights Reserved.



Manufactured under a license from U.S. Patent No's: 6,285,767, 8,027,477, 5,319,713, 5,333,201, 5,638,452, 5,771,295, 5,970,152, 5,912,976, 7,200,236, 7,492,907, 8,050,434, 7,720,240, 7,031,474, 7,907,736 and 7,764,802. DTS, the Symbol, and DTS and the Symbol together are registered trademarks & DTS Studio Sound is a trademark of DTS, Inc. ©2012 DTS, Inc. All Rights Reserved.



The terms HDMI and HDMI High-Definition Multimedia Interface, and the HDMI Logo are trademarks or registered trademarks of HDMI Licensing LLC in the United States and other countries.



DivX Certified® to play DivX® video up to HD1080p, including premium content.
DivX®, DivX Certified® and associated logos are trademarks of DivX, LLC and are used under license.

This DivX Certified® device has passed rigorous testing to ensure it plays DivX® video. To play purchased DivX movies, first register your device at vod.divx.com. Find your registration code in the DivX VOD section of your device setup menu.
Covered by one or more of the following U.S. patents: 7,295,673; 7,460,668; 7,515,710; 8,656,183; 8,731,369; RE45,052.

Open Source Licence Notice

In the case of using open source software, Open Source Licences are available on the product menu. Open Source Licence Notice is written only English.
For information on the Open Source Licence Notice, contact the Samsung Customer Center or send email to oss.request@samsung.com.

Terminology

480i / 480p / 720p / 1080i / 1080p_____ Each of the scanning rates above refers to the number of effective scanning lines that decides the screen resolution. The scanning rate may be indicated in i (interlaced) or p (progressive), depending on the scanning method.

- Scanning

Scanning refers to a process of sending pixels that form an image progressively. A larger number of pixels will deliver a clearer and more vivid picture.

- Progressive

In progressive scan mode, all lines of pixels are scanned one by one (progressively) on the screen.

- Interlaced

In interlaced scan mode, every other line of pixels is scanned from top to bottom first and then the remaining lines of pixels (that were not scanned) are scanned.

Non-interlace Mode and Interlace Mode_____ Non-interlace mode (progressive scan) displays a horizontal line from the top to the bottom of a screen progressively. Interlace mode displays the odd number lines first and the even number lines next. Non-interlace mode is mainly used in monitors as it produces screen clarity and interlace mode is mainly used in TVs.

Dot Pitch_____ The screen consist of red, green and blue dots. A shorter distance between the dots produces a higher resolution. Dot pitch refers to the distance between the shortest distance between dots of the same color. Dot pitch is measured in millimeters.

Vertical Frequency_____ The product displays a single image many times per second (like a fluorescent light that flickers) to display an image for a viewer to see. The rate of a single image being displayed repeatedly per second is called vertical frequency or refresh rate. Vertical frequency is measured in Hz. E.g. 60Hz refers to a single image being displayed 60 times in one second.

Horizontal Frequency_____ The time required to scan a single line from the left to the right side of the screen is called a horizontal cycle. The reciprocal number of a horizontal cycle is called horizontal frequency. Horizontal frequency is measured in kHz.

Source_____ Input source refers to a video source device connected to the product such as a camcorder or video or DVD player.

Plug & Play_____ Plug & Play is a function that allows the automatic exchange of information between a monitor and PC to produce an optimum display environment. The product uses VESA DDC (international standard) to execute Plug & Play.

Resolution_____ Resolution is the number of horizontal dots (pixels) and vertical dots (pixels) that form a screen. It represents the level of display detail. A higher resolution enables more data to be displayed on the screen and is useful to perform multiple tasks simultaneously. E.g. A resolution of 1920 X 1080 consists of 1,920 horizontal pixels (horizontal resolution) and 1,080 vertical pixels (vertical resolution).

DVD (Digital Versatile Disc)_____ DVD refers to a CD-sized mass storage disk where you can save multimedia (audio, video or game) applications using MPEG-2 video compression technology.

HDMI (High Definition Multimedia Interface)_____ It is an interface that can be connected to a digital audio source as well as a high-definition video source by using a single cable without compression.

Multiple Display Control (MDC)_____ MDC (Multiple Display Control) is an application that allows multiple display devices to be controlled simultaneously using a PC. Communication between a PC and monitor takes place using RS232C (serial data transmission) and RJ45 (LAN) cables.