

SOLID EXIT 2

LED EXIT LIGHT WITH A LIGHT PLATE AND A VIEWING DISTANCE OF 30 M,
FOR SURFACE MOUNTING ON A CEILING



The SOLID LED exit light is equipped with a light plate. The luminaire is designed specifically to withstand harsh conditions. It is a 2-sided IP65 enclosure classed luminaire and completely dust and water proof.

SOLID is suitable for example for industrial premises, parking halls and outdoor use. The luminaire uses long lasting leds as its light source.

Special attention has been paid to the design for easy installation.

DIMENSIONS

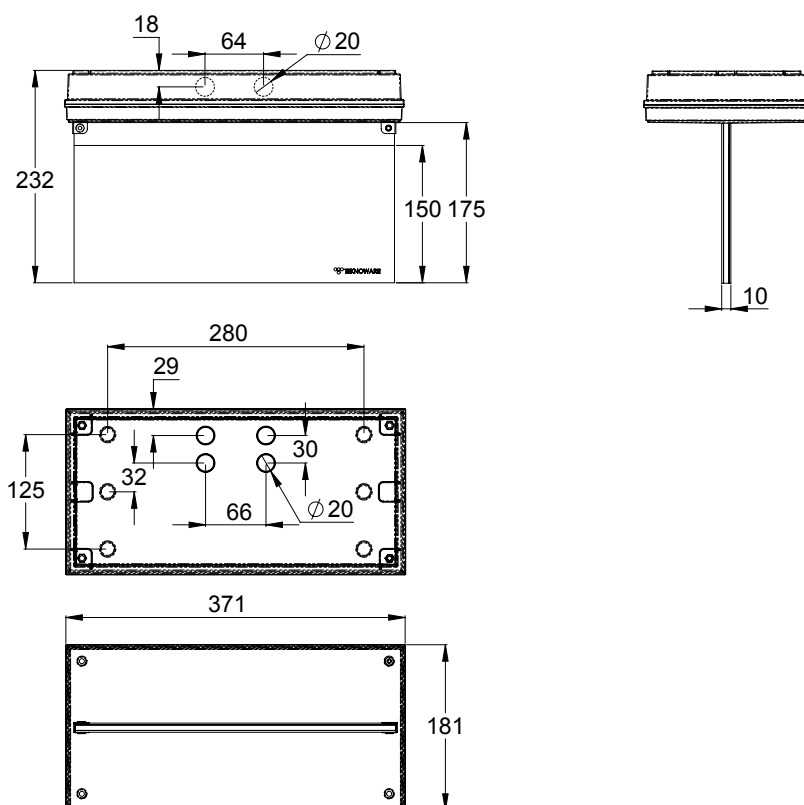

= Protection class of luminaire is 2 = Protection rating **Aalto** = Aalto Control compatible (incl. Lumi Test) = compliant with the 850 glow wire test
 = Protection class of luminaire is 3 = Colour of the body **M** = Self-contained luminaire with Lumi test self-testing **IC** = Compatible with Intelligent Controller
 = Protection class of luminaire is 3 = Viewing distance **Escap** = Self-contained luminaire with 1 h super capacitor backup **CBS** = Centrally supplied
 = Luminaire is suitable for through-wiring = LED as a light source **C** = Compatible with Tapsa Control Central Battery Unit and Local Controller

CENTRALLY SUPPLIED LUMINAIRE

24-230V CENTRALLY SUPPLIED EXIT LIGHTS

Product code	Nominal supply voltage	Max input power	Operation mode	Temperature range	Electrical installation	Weight (kg)
TWT3171W	24-230 V, 50/60 Hz AC	24 V=8 VA / 5 W 230 V=15 VA / 6 W	CBS	-30... +50°C	24 V=2 x 2,5 mm ² 230 V=3 x 2,5 mm ² -o-	1,8
Y3171W143	(individually packed incl. TWT3171W + pictogram, 2-sided)					
Y3171W148	(individually packed incl. TWT3171W + pictogram, 1-sided)					
Y3171W147	(individually packed incl. TWT3171W + pictogram, 1-sided)					
Y3171W145	(individually packed incl. TWT3171W + pictogram, 2-sided)					
Y3171W149	(individually packed incl. TWT3171W + pictogram, 1-sided)					

230V CENTRALLY SUPPLIED EXIT LIGHTS









Product code	Nominal supply voltage	Max input power	Operation mode	Temperature range	Electrical installation	Weight (kg)
TWT3151WK	220-240 V, 50/60 Hz AC	6 VA / 3 W	CBS / C + IC	-30... +50°C	2/3 x 2,5 mm ² -o-	1,8
Y3151WK143	(individually packed incl. TWT3151WK + pictogram, 2-sided)					
Y3151WK148	(individually packed incl. TWT3151WK + pictogram, 1-sided)					
Y3151WK147	(individually packed incl. TWT3151WK + pictogram, 1-sided)					
Y3151WK145	(individually packed incl. TWT3151WK + pictogram 2-sided)					
Y3151WK149	(individually packed incl. TWT3151WK + pictogram, 1-sided)					

SOLID EXIT 2



SEPARATELY ORDERED PICTOGRAMS

Product code	Pictogram	Product description
PBV31302E		Down arrow 2-sided
PBV31302E3		Down arrow, 1-sided
PB31301E		Left/right arrow, 2-sided
PBV31301E1		Right arrow, 1-sided
PBV31301E2		Left arrow, 1-sided
PBV31305E		Up arrow 2-sided
PBV31305E3		Up arrow, 1-sided